

## Thank You for Purchasing an Eagle Bridge™ Trailer

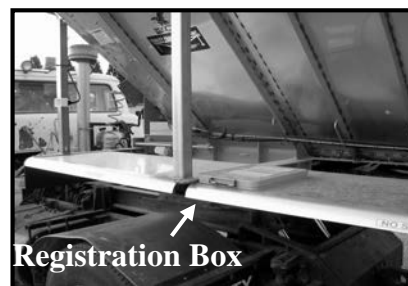
The purpose of this manual is to address:

- Safety
- Warranty Information
- Service and Maintenance
- General Care and Use
- Conveyor Operating Instructions
- Rear Door Operating Instructions
- General Support Information

Please refer to the Table of Contents to locate the needed information. If you have questions about the trailer which are not covered in this manual, please call us at (208) 336-3666 or toll free at (800) 235-6577. Our hours of operation are Monday through Friday, 8:00 a.m. to 5:00 p.m., MST.

This manual is written to cover many versions of Eagle Bridge™ trailers. Because of this, some sections are not applicable to your trailer. Thoroughly review the manual and any attached supplements to determine what is applicable to your trailer.

Two print copies are supplied with each trailer; one copy with warranty packet and the second in the registration box located on the front fender of the trailer, shown in the figure below. This manual is considered a permanent part of the trailer and should remain with the trailer if ownership is transferred in any way. To replace a missing or destroyed manual, call 800-235-6577 or download at [www.trinitytrailer.com/resources/](http://www.trinitytrailer.com/resources/)



Registration Box Location

*Notice: Contents of this manual are subject to change without notice!*

## TABLE OF CONTENTS

<b><u>TABLE OF CONTENTS</u></b>	II, III, IV
<b><u>LIMITATION OF WARRANTIES</u></b>	V
<b><u>IMPORTANT SAFETY INFORMATION</u></b>	VI
<b><u>WARNING SYMBOLS USED IN THIS MANUAL</u></b>	1
<b>SAFETY LABELS</b>	1
<b><u>INSPECTION, SERVICE AND MAINTENANCE</u></b>	2
<b>DAILY INSPECTION</b>	2
<b>PREVENTATIVE MAINTENANCE SCHEDULE</b>	2
After the first 50 to 100 miles	2
After the first 1,000 miles	2
After the first 50 hours of operation	2
Every 100 hours of operation	3
Every 250 hours of operation	3
Every 2,500 miles or Bi-weekly	3
Every 5,000 miles or once a month (whichever comes first)	3
Every 15,000 miles or three months	3
Once a year	4
<b>HONDA 20HP GASOLINE ENGINE MAINTENANCE SCHEDULE</b>	5
<b>FIFTH WHEEL AREA INSPECTION</b>	6
<b>ADJUSTING AND LUBRICATING THE CONVEYOR SYSTEM</b>	7
Conveyor Chain Adjustment	7
Adjusting the Chain	8
Removing Chain Links	8
Welding Chain Pins	8
Conveyor Chain Lubrication	10
Bearings and Sprockets	11
Planetary Gearbox	12
Changing Planetary Oil	12
<b>LUBRICATION OF THE DOOR(S)</b>	13
<b>CARE OF THE PLASTIC LINER</b>	14
<b>High Molecular Weight (HMW) and Ultra-High Molecular Weight (UHMW) Liner</b>	14
<b>COATING CARE AND CORROSION PREVENTION</b>	14
<b>STAINLESS STEEL BODIES</b>	15
<b>CLEANING THE INTERIOR</b>	15
<b>SPRING SUSPENSION INSPECTION AND MAINTENANCE</b>	16
Spring Suspension Inspection	16
Axle Clamps and Springs	17
Radius Rods	18
Rocker Bushings	18
Hangers	19
Spring Suspension Alignment	19
<b>AIR-RIDE SUSPENSION INSPECTION AND MAINTENANCE</b>	21
Air-Ride Suspension Inspection (Hendrickson HT Series, INTRAAX®),	

Composilite™ and Ingersoll ISS Series)	21
Hendrickson Suspension Torque Requirements	22
Composilite™ Torque Requirements	23
ISS Series Torque Requirements	24
Air-Ride Suspension Alignment	25
Quick-Align Connection	25
Composilite™ Alignment	28
ISS Series Alignment	29
ISS Series SSA Alignment	31
<b>HUB AND WHEEL INSTALLATION AND MAINTENANCE</b>	34
Pilot Mount Wheels	34
Recommended Procedure for Replacing Studs	36
<b>HYDRAULIC SYSTEM SERVICING</b>	36
Tractor Hydraulic System Requirements	36
Pressure Filters	36
Hydraulic Cylinder Maintenance	37
Hydraulic Lines and Fittings	38
Hydraulic Fluid Recommendations	38
<b>GASOLINE ENGINE SERVICING</b>	38
<b>ANTI-LOCK BRAKE SYSTEM (ABS)</b>	39
Ignition Power Activation	41
<b>REAR IMPACT GUARD</b>	41
<b><u>OPERATING INSTRUCTIONS</u></b>	42
<b>COUPLING THE TRAILER</b>	42
<b>A NOTE ON AIR PRESSURE</b>	44
<b>LOADING THE TRAILER</b>	45
<b>ELECTRONIC SCALES</b>	46
<b>LIFT AXLE CONTROLS</b>	46
Equalizing Lift Controls	46
AKAD2010 Lift Control	47
LSAS (Load Sensing Axle System) Lift Control	47
RA016SRA-32L Suspension Control	48
Regulating Lift Controls	50
HAC-USO/LSO Lift Control	51
AKAD2011 Lift Control	52
<b>TIRE INFLATION SYSTEMS</b>	53
<b>TIREMAAX® PRO</b>	53
<b>DRIVE AND HYDRAULIC SYSTEMS</b>	54
Supplying Power to the Electric Motor	54
<b>OPERATING THE REAR DOOR(S) AND UNLOADING SYSTEM</b>	55
Door and Conveyor System Component Identification	55
Lower Door Identification	55
Lower Door Component Identification	56
Upper Door Identification	57
Upper Door Component Identification	59
Unload Drive System Identification	62

Door and Conveyor Control Identification	63
<b>GENERAL DOOR SAFETY</b>	65
<b>GENERAL CONVEYOR SAFETY</b>	66
<b>UNLOAD OPERATING PROCEDURES</b>	67
<b>ENGAGE HYDRAULIC SYSTEM PROCEDURES</b>	67
Electric Motor-Driven Hydraulic System	67
Gas Engine-Driven Hydraulic System	67
Tractor-Driven PTO Hydraulic System	68
<b>OPEN REAR DOOR PROCEDURES</b>	68
Lower Door Procedures	69
Manual Flip-Up Door	69
Manual Flip-Up Spud Door	69
Hydraulic Flip-Up or Slider	69
Upper Door Procedures	69
Full-Swing Door	69
Top-Hinge Door with Pneumatic Lift	70
Top-Hinge Door with Hydraulic Lift	70
<b>OPERATE THE CONVEYOR</b>	71
<b>CLOSE REAR DOOR PROCEDURES</b>	71
Upper Door Procedures	71
Full-Swing Door	71
Top Hinge Door with Pneumatic Lift	72
Top-Hinge Door with Hydraulic Lift	72
Lower Door Procedures	72
Manual Flip-Up Door	72
Manual Flip-Up Spud Door	72
Hydraulic Flip-Up or Slider	72
<b>OPERATING LOADING ACCESS DOORS</b>	73
Fold-Down Spud Door	73
Fold-Down Extension (Sideboard) Door	73
<b>OPERATING THE PNEUMATICALLY-ACTUATED FRONT WET SEAL</b>	75
<b>USING THE REMOVABLE TAILFINS</b>	76
<b>TARP SYSTEMS</b>	77
<b><u>LADDER, WALKWAY AND CATWALK SAFETY</u></b>	80
<b><u>LADDER USE PROCEDURE</u></b>	83
<b>REAR MAINTENANCE LADDER</b>	85
<b><u>TRAILER MODIFICATIONS</u></b>	87
<b><u>REPORTING SAFETY DEFECTS</u></b>	88

## **LIMITATION OF WARRANTIES**

Goods manufactured by Trinity Trailer Manufacturing, Incorporated (“Trinity Trailer”) are warranted to be free from defects in workmanship or material under normal use and service for a period of **One (1) year to THE ORIGINAL OWNER** or any remaining time on the warranty period for **SUBSEQUENT OWNERS**.

This warranty is applicable if the owner has, as a minimum:

- Properly maintained the trailer
- Not overloaded the trailer (i.e. Exceeded the GVWR\* or the GAWR\*)
- Not transported corrosive cargo
- Adequately restrained the load
- Loaded the trailer properly

The warranty period begins on the date the vehicle is delivered and ends at the expiration of the coverage period.

**THERE ARE NO WARRANTIES OF MERCHANTABILITY AND FITNESS FOR A PARTICULAR PURPOSE, OR OTHER WARRANTIES, EXPRESSED OR IMPLIED, UNLESS OTHERWISE EXPRESSLY SPECIFIED HEREIN.**

Trinity Trailer’s sole obligation under this warranty is to repair or exchange, at its option, any such goods manufactured which are found by Trinity Trailer to be defective in workmanship or materials. Trinity Trailer reserves the right to require any products to be returned for inspection at the buyer’s expense to our facility in Boise, Idaho. The foregoing shall be the sole and exclusive remedy for any such defects, whether in contract, tort, warranty or otherwise.

**In no event** shall Trinity Trailer be liable for indirect, special, incidental or consequential damage in connection with or arising out of the sale of goods or furnishing services.

The warranty herein **does not apply** to and Trinity Trailer makes no warranties, expressed or implied with respect to:

- Items manufactured by other parties
- Items that have been modified by other parties
- Goods which wear out and have to be replaced during the warranty period. These goods include but are not limited to: tires, plastic liner, chains, flaps, tarp, light bulbs, electrical or hydraulic receptacles, paint, brakes, linings, drums and return springs, equalizer, torque rod, camshaft bushings, camshafts, slack adjusters, brake cylinder diaphragms, springs, slider pads, wheel bearings, oil and oil seals, door seals, rim clamps and studs, gaskets, sealers, and filters etc.

**\*GVWR (Gross Vehicle Weight Rating)**-The structural capability of the trailer when supported by the kingpin and axles with the load uniformly distributed throughout the cargo space.

**\*GAWR (Gross Axle Weight Rating)**-The structural capability of the lowest rated member of the running gear components-suspension and spring system, hub, wheels and drums, rims, bearings, brakes, axles or tires.

## **IMPORTANT SAFETY INFORMATION**

**Before attempting to operate, load, unload or do anything with or to the trailer, YOU MUST READ THIS MANUAL and become completely familiar with all of its operating instructions and safety precautions.**

**To avoid serious injury or death, ALWAYS FOLLOW THESE PRECAUTIONS:**

1. Do not allow unqualified, untrained or careless personnel to operate the trailer. Do not use the trailer for a purpose for which it was not intended.
2. Each person at the user's facility who may be involved with installing, operating, servicing, inspecting, maintaining or repairing the trailer must read the complete operating instructions and carefully study and understand the safety instructions. All actual and potential operators should confirm their having done so in writing.
3. The trailer must be serviced and maintained only by authorized and properly trained personnel. Such personnel must have undergone training by a factory-trained representative concerning the proper and safe operation of the trailer. Only the manufacturer or factory-trained technicians should carry out more than minor repairs.
4. Do not allow anyone who is not physically fit or mentally alert near the trailer or its operating area. Be constantly alert to possible hazards on or around the trailer.
5. Keep a safe distance at all times from any moving parts, including the conveyor.
6. When unloading the trailer:
  - a. Long hair must be protected by headgear.
  - b. Do not wear loose apparel such as ties, scarves, etc.
  - c. Remove all wristwatches and jewelry.
  - d. Wear only approved industrial grade eye protection or a face guard to protect against flying debris.
7. Do not allow tools or other loose objects to be placed on top of or around the trailer.
8. At the very first sign of any problem and before attempting any troubleshooting or maintenance, the conveyor must be stopped.
9. Safety features must not be removed, dismantled, altered, put out of operation or relocated. All guards and safety devices are to be re-fitted and in place after changeovers, servicing or making repairs and before the trailer is used. All safety devices must be checked at regular intervals for correct operation.
10. Do not remove safety signs or warning decals from the trailer. Product safety signs should be periodically inspected and cleaned as necessary. Product safety signs should be replaced when they are no longer legible at a normal viewing distance. Replacements are available from Trinity Trailer Mfg., Inc.
11. Follow all workplace safety and accident prevention regulations applicable to the operation of the trailer. Comply with local, state and/or federal environmental regulations, including those governing airborne dust particles.
12. Designate a person to be responsible at any given time for installation, commissioning, operating and repair of the trailer so the responsibility for safety will not be lost.
13. The trailer has been designed and built with original Trinity Trailer Mfg., Inc. parts only. Only original Trinity Trailer Mfg., Inc. parts must be used for maintenance or repair. Use of other parts will void your warranty.
14. Do not perform modifications to or reconstruction of the trailer without first getting written approval from Trinity Trailer Mfg. Inc.
15. The cleanliness and tidiness of the trailer and its surrounding area must be ensured through appropriate instructions, routine inspections and cleaning.

## **WARNING SYMBOLS USED IN THIS MANUAL**

Eagle Bridge™ trailers have inherent hazards associated with their use. We have made efforts to minimize these risks through the use of engineering controls. There are certain risks, however, which cannot be completely eliminated if the design is to remain functional.

The following symbols and classifications of hazards are used in this manual and on the safety labels on the trailer.



This is a safety alert symbol. It is used to alert you to potential personal injury hazards. Obey all safety messages that follow this symbol to avoid possible injury or death.



**WARNING**

This indicates a potentially hazardous situation which, if not avoided, could result in death or serious injury.



**CAUTION**

This indicates a potentially hazardous situation which, if not avoided, could result in minor or moderate injury.

**CAUTION**

A caution statement used without the safety alert symbol indicates a potentially hazardous situation which, if not avoided, may result in property damage.

## **SAFETY LABELS**

Your trailer had numerous safety labels affixed to it when it was built; they are shown throughout this manual. It is important that these labels remain visible and legible throughout the life of the trailer. To help ensure they are visible, the trailer should be cleaned regularly with water and a mild detergent. Over time the condition and/or color of the labels may deteriorate due to use of the trailer and the environment in which it is used. If the labels should become illegible or lose their color, it is the owner's responsibility to replace them. Contact our customer service department at (800) 235-6577 to order replacements.

## **INSPECTION, SERVICE AND MAINTENANCE**

It is important that your Eagle Bridge™ trailer be inspected and serviced on a regular basis to keep it in a safe and functional condition. Regular maintenance will also save you money in costly repairs over time.

### **DAILY INSPECTION**

A daily inspection of the following items should be performed before using the trailer:

- Bin and Support Members
- Belt Return Slides
- Bolts and Fasteners
- Brake Adjustment
- Brake Pad Thickness
- Brake System
- Conveyor System
- Coupler Plate
- Fasteners
- Framework
- Hub Oil Level
- Hydraulic Oil Filters
- Hydraulic System
- Kingpin
- Ladders
- Lights and Wiring
- Mud Flaps
- Plastic Liner
- Pneumatic System
- Suspension System
- Tarp Hardware
- Tarps
- Tires
- Wheels
- Wheel Seals

### **PREVENTATIVE MAINTENANCE SCHEDULE**

We recommend that you follow the general preventative maintenance schedule below. The intervals given are for nominal operating conditions; service more frequently if the trailer is used in an overly humid or dusty condition.

#### **AFTER THE FIRST 50 TO 100 MILES**

- Check torque of cap nuts or flange nuts on each wheel

#### **AFTER THE FIRST 1,000 MILES**

- Check torque of suspension hardware
- Check alignment of suspension

#### **AFTER THE FIRST 50 HOURS OF OPERATION**

- Replace the hydraulic oil and filter
- Replace the oil in the planetary gearbox



**EVERY 100 HOURS OF OPERATION**

- Clean the spark arrester on the gasoline engine (if applicable)

**EVERY 250 HOURS OF OPERATION**

- Replace the hydraulic oil filter

**EVERY 2,500 MILES OR BI-WEEKLY (WHICHEVER COMES FIRST)**

- Lubricate the pins and bolted connections on the maintenance ladder with a spray lubricant (such as WD40).
- Check all maintenance ladder bolted connections and verify that they are tight

**EVERY 5,000 MILES OR ONCE A MONTH (WHICHEVER COMES FIRST)**

- Wash trailer thoroughly with a mild detergent and water
- Check general structural condition for corrosion or cracks
- Inspect kingpin area
- Check clearances and torque of air-ride suspension system (if applicable)
- Visually check alignment of suspension
- Check condition of lights
- Check security of registration box and required paperwork
- Check wiring harness for cracking or chafing
- Check hydraulic and pneumatic lines for signs of leakage or wear
- Drain moisture from air reservoirs
- Check hinges on rear door(s) for signs of damage
- Lubricate hinges, latches and bearings (if applicable) on rear door(s)
- Inspect brake components for proper adjustment and for any sign of damage
- Check tires for excessive wear and proper inflation
- Check wheel nuts for proper torque
- Check wheel seals for leaks
- Check level of oil in axles
- Check conveyor system for excessive wear or damage
- Check condition of tarp system, if installed
- Check condition and security of mud flaps
- Check oil level in planetary gear on conveyor hydraulic and add if necessary

**EVERY 15,000 MILES OR THREE MONTHS**

All items listed above plus:

- Check all hardware; replace any which are damaged or missing; tighten any loose bolts or nuts
- Clean grease off kingpin plate and inspect for excessive wear or cracks

- Measure alignment of suspension; adjust if out of allowable tolerance
- Inspect all welded connections and joints on suspensions
- Check for proper torque of all bolts and nuts on the suspension system
- Replace hub bearing lubricant
- Lubricate automatic slack adjusters
- Inspect brake drums, lining and shoes
- Test operation of brakes
- Inspect brake lines for wear or chafing
- Lubricate conveyor chains and front shaft bearings
- Check condition of front and rear chain sprockets and bearings for wear or damage
- Check lining of the trailer for cracks or damage; check floor lining for excessive wear
- Check condition of glad hand seals
- Lubricate the door seals
- Service gasoline engine in accordance with the manufacturer's recommended procedures (if applicable)
- Check aluminum sidewall extensions for damage or cracking (if applicable)

#### **ONCE A YEAR**

All items listed above plus:

- Drain and replace hydraulic fluid from reservoir
- Replace hydraulic oil and filter (or every 1,000 hours, whichever is first)
- Replace oil in the planetary gearbox (or every 1,000 hours, whichever is first)
- Lubricate landing legs

## HONDA 20HP GASOLINE ENGINE MAINTENANCE SCHEDULE

<b>REGULAR SERVICE PERIOD (3)</b> Perform at every indicated month or operating hour interval, whichever comes first.		<b>Each Use</b>	<b>First Month or 20 Hrs</b>	<b>Every 6 Months or 100 Hrs</b>	<b>Every Year Or 300 Hrs</b>	<b>Every 2 Years or 500 Hrs</b>
<b>ITEM</b>						
<b>Engine Oil</b>	Check Level	o				
	Change		o	o		
<b>Engine Oil Filter</b>	Replace	Every 200 Hrs				
<b>Air Cleaner</b>	Check	o				
	Clean			o (1)		
	Replace					o *
<b>Spark Plug</b>	Check/Adjust			o		
	Replace				o	
<b>Spark Arrester (Applicable Types)</b>	Clean			o		
<b>Idle Speed</b>	Check/Adjust				o (2)	
<b>Valve Clearance</b>	Check/Adjust				o (2)	
<b>Combustion Chamber</b>	Clean	After Every 1000 Hrs (2)				
<b>Fuel Filter</b>	Replace				o (2)	
<b>Fuel Tube</b>	Check	Every 2 Years (Replace if necessary) (2)				

\*Replace the paper filter element only.

(1) Service more frequently when used in dusty areas.

(2) These items should be serviced by your Honda servicing dealer, unless you have the proper tools and are mechanically proficient. Refer to the Honda shop manual for service procedures.

(3) For commercial use, log hours of operation to determine proper maintenance intervals.

**Figure 1-Honda 20HP Gasoline Engine Maintenance Schedule**

## FIFTH WHEEL AREA INSPECTION

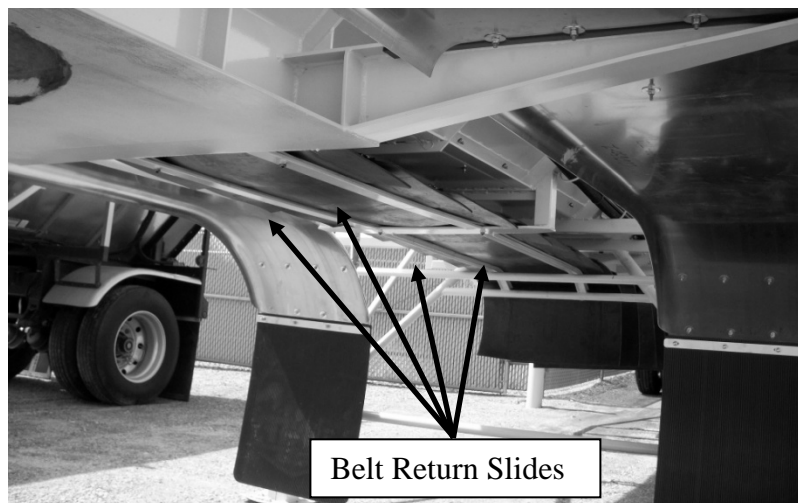
The fifth wheel area must be kept clean and free of dirt and foreign materials. This includes the area between the kingpin plate and the body of the trailer where the conveyor chains and flaps travel. Buildup of snow, ice or other foreign materials can cause binding or other serious damage if allowed to remain in this area. Any binding can place excess stress on the front shaft, which can result in any of the following:

- The shaft to bend or break
- The bearings or adjustment mechanisms to be damaged
- The chain to stretch excessively, resulting in premature failure

Daily inspect the kingpin and kingpin plate for the following:

- Wear, cracks or other damage
- Damaged or missing parts
- Bent belt return slides (Figure 2); these can be bent during normal operation and must be straightened before use

Keep the fifth wheel plate lubricated in accordance with the tractor manufacturer's recommendations.

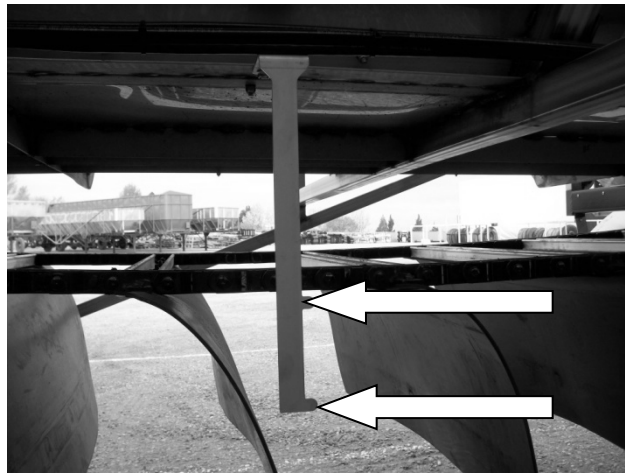


**Figure 2-Belt Return Slides**

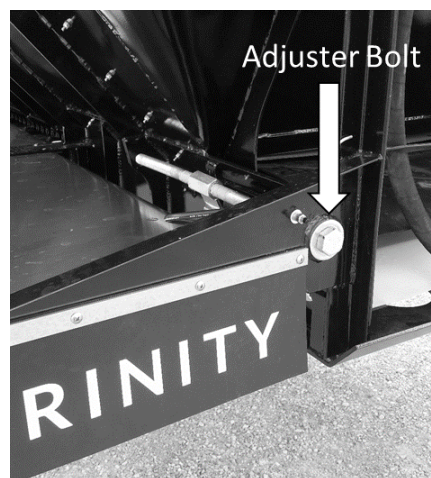
## ADJUSTING AND LUBRICATING THE CONVEYOR SYSTEM

### CONVEYOR CHAIN ADJUSTMENT

It is normal for the chain to "stretch" as it is used. The amount of "stretch" will be greater when the chain is new as the pins get seated against the barrel of the chain. It is important to keep the chain adjusted to prolong the life of the chain. The chain should be operated within the two pointers on the chain adjustment gauge (Figure 3), which is located on the roadside of the trailer between the front of the suspension and the center of the trailer.



**Figure 3** - Chain Adjustment Gauge



**Figure 4** - Chain Adjustment Assembly

## **ADJUSTING THE CHAIN**

1. Tighten the adjuster bolt (Figure 4), alternating sides so that one side of the shaft does not exceed 1/4" ahead of the opposite side, until the chain is between the two pointers on the chain adjustment gauge (Figure 3).
2. If the chain adjustment assembly is out of adjustment and the chain is not within the two pointers, you will have to remove some chain links. (Procedure to follow)
3. Measure the distance from front of trailer to the shaft on each side and adjust so that there is no more than 1/8" difference.

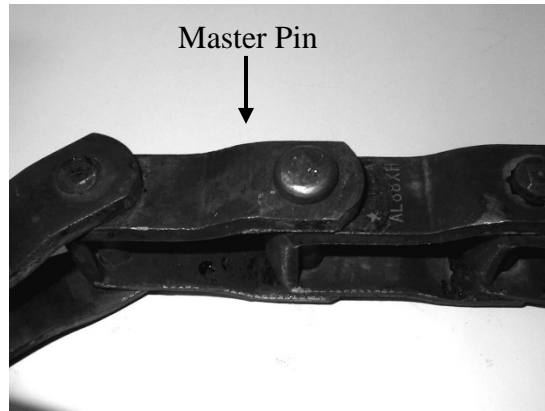
## **REMOVING CHAIN LINKS**

1. Rotate the conveyor until there is a master pin 3 - 5 feet in front of the suspension. The master pin can be identified by the head of the pin (Figure 5).
2. Loosen the adjuster bolt (Figure 4), alternating sides so that one side of shaft does not exceed 1/4" behind the opposite side, until the sprocket teeth are just in front of the trailer floor.
3. Verify that the shaft can rotate without the sprockets hitting the trailer floor.
4. In front of the suspension connect a Come-Along into the chain links of each chain with the master pin centered between the connection points.
5. Pull up all of the slack chain (Figure 6).
6. Grind the weld off of the master pins.
7. Drive out the pin using a punch.
8. Pull up the slack to determine how much of the chain to remove (Figure 7). You may have to remove links from both sides of the split. You should remove links so that you do not have more than 5 links between flaps.
9. Grind off the head of the pin you need to remove (Figure 8).
10. Drive out the pin using a punch.
11. Connect the chain using a new pin and cotter pin.
12. Weld the chain pins using the following procedure.
13. Remove the Come-Along from each chain.
14. Adjust the chain using the previous procedure.

## **WELDING CHAIN PINS**

The pin must be secure and should not be able to freely rotate within the link as this can cause accelerated wear and result in failure of the pin.

1. Place the ground clamp from the welder on the chain itself near the link to be welded. Placing the ground on the body of the trailer will not allow enough current to pass through the link to obtain a sufficient weld.
2. Weld the pin on the "trailing" edge of the pin. Weld between the pin and the link, not just the pin and the cotter pin (Figure 9).
3. No weld is required on the opposite side of the chain where the head of the pin meets the link (Figure 5).



**Figure 5 - Master Pin Identification**



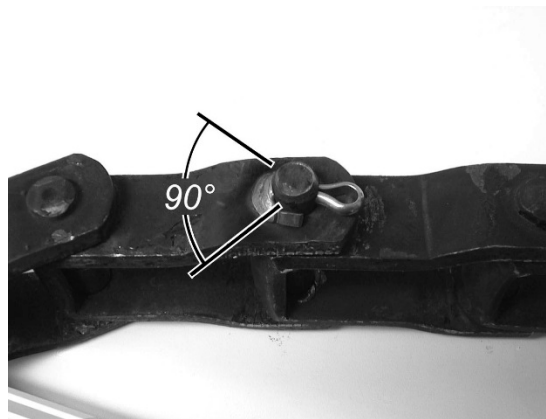
**Figure 6 - Using Come-Along To Pull Up Chain Slack**



**Figure 7 - Determine How Much Chain to Remove**



**Figure 8 - Chain Pin with Head Ground Off**



**Figure 9 - Properly Welded Pin**

## **CONVEYOR CHAIN LUBRICATION**

The conveyor chain must be inspected regularly and lubricated using a high quality oil. Do not use grease. Any type of lubricant may be used depending on products hauled and individual preference. A good general purpose lubricant is chain and cable fluid, which has penetrating qualities as well as dust repellent. Use Table 1 to determine which grade of lubricant to use based upon the operating temperature.



<b>Temperature (Degree °F)</b>	<b>Recommended Lubricant</b>
-20 to 20	SAE 10
20 to 40	SAE 20
40 to 100	SAE 30
100 to 120	SAE 40
120 to 140	SAE 50

**Table 1-Chain Lubricant Guide**

How often the chains need lubrication is dependent upon the amount of use and the type of product carried.

- Under daily use or in harsh environments, daily inspection is required. Lubricate as needed.
- Under all other uses, weekly inspection should be sufficient. Lubricate as needed.
- If a food-grade lubricant is used, you may need to apply it more often. It is your responsibility to determine how often lubrication is required.



Attempting to lubricate the chains while they are in motion can result in serious bodily injury or death. Stay clear of the chains while they are in motion. Position the chains and completely disable the hydraulic system before doing any maintenance.

Remember, proper lubrication can extend chain life, reduce down time and save you money.

## **BEARINGS AND SPROCKETS**

The bearings on the front and rear conveyor shafts must be inspected and lubricated at regular intervals using an NLGI Grade 2 general-purpose grease. As with chain lubrication, the amount of lubrication is dependent upon the amount of use.

- Under daily use, daily inspection is required. Lubricate as needed.
- Under all other uses, weekly inspection should be sufficient. Lubricate as needed.
- Inspect sprockets for excessive wear or damage.



Attempting to lubricate the bearings while the shaft is rotating can result in serious bodily injury or death. Stay clear of the bearings while they are rotating. Completely disable the hydraulic system before doing any maintenance on the bearings.

## PLANETARY GEARBOX

When using the planetary gearbox under normal temperature ranges between 0-120 °F, the gearbox is to be half full of SAE 80/90 oil. Use the middle plug located at the three o'clock position to check the level of the oil. Oil is to be changed after the first 50 hours of operation with subsequent changes every 1000 hours or yearly, whichever comes first.

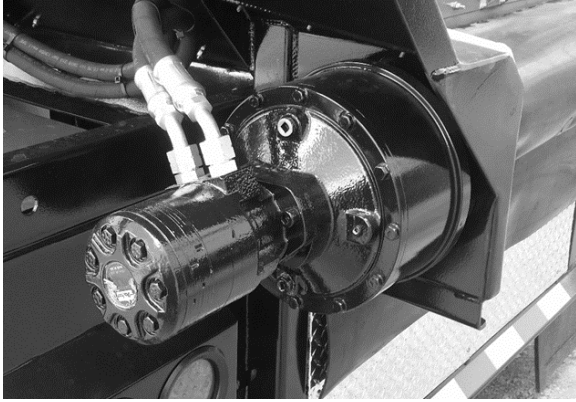
### NOTE

**There is absolutely no warranty, expressed or implied, on the chain or drive system if the system is not maintained properly, is misused or is overloaded. This includes, but is not limited to the hauling of corrosive materials such as fertilizer, sludge, brewer's mash or corn gluten.**

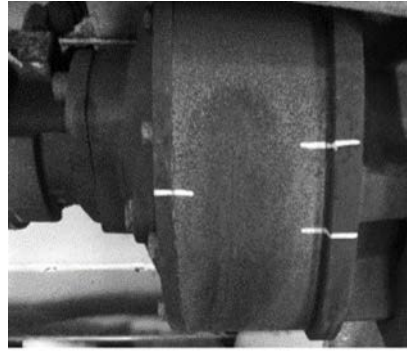
## CHANGING PLANETARY OIL

The following are basic instructions for changing the oil in the planetary.

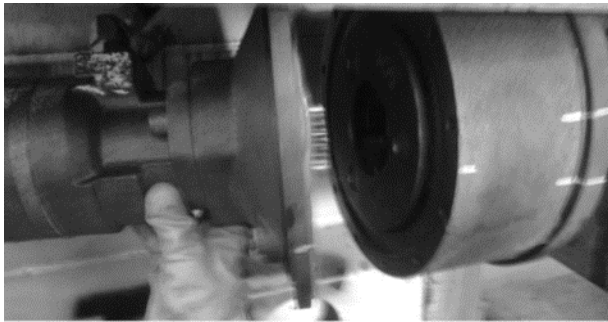
1. Label and remove the hydraulic lines from the hydraulic motor (Figure 10).
2. Mark position of the planetary cover and ring gear for reassembly (Figure 11).
3. Remove the cover with motor attached (Figure 12).
4. Remove all gear sets.
5. Remove the ring gear.
6. Clean and inspect all gears for chipped, cracked, pitted, or rusty teeth.
7. Apply a small bead of silicone to all sealing surfaces.
8. Install ring gear.
9. Install all gear sets.
10. Install cover and torque all bolts to 45 lb-ft.
11. Remove the fill and full plugs from the cover (Figure 13).
12. Add SAE 80/90 gear oil through the fill hole until oil comes out of full hole.
13. Reinstall plugs into cover.
14. Reconnect the hydraulic lines to the hydraulic motor.



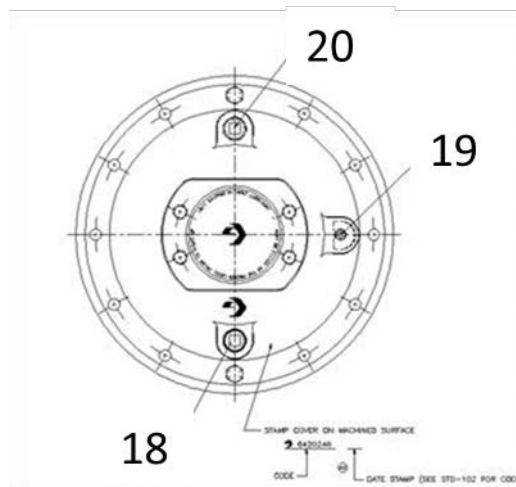
**Figure 10-** Planetary Assembly



**Figure 11-** Planetary alignment



**Figure 12-**Removal of the Planetary Cover



**Figure 13-**Plug 20 for Fill, Plug 19 for Full, Plug 18 for Drain

## LUBRICATION OF THE DOOR(S)

Door hinges and bearings must be lubricated regularly, especially if the trailer has been operated or stored for an extended period of time in a humid or wet environment. Corrosion can lead to the failure of door hinges if they are not maintained properly. As a general rule with the rear doors, as with the entire trailer, “if it moves, lubricate it.” Use a NLGI Grade 2 general-purpose grease on all shafts and grease zerks.

The seals on most doors should have silicone grease or spray-on lubricant applied to them once every three months. This will help them last longer and will help them provide a better seal. During cold, damp weather or under heavy use, apply the grease more frequently.

## CARE OF THE PLASTIC LINER

### HIGH MOLECULAR WEIGHT (HWM) AND ULTRA-HIGH MOLECULAR WEIGHT (UHMW) LINER

The plastic liner under the chain (and on the slopes, if applicable) must be inspected for damage and wear. Replace the liner if it is worn through at any spot. If any foreign material should become lodged between the liner and the body of the trailer, remove it by blowing or vacuuming it out.



Use eye protection when using air to blow material from underneath the liner to help prevent injuries from flying particles.



Getting inside the trailer with the door(s) closed or the hydraulic system energized can result in serious injury or death. Open door(s) and disable all hydraulic systems before entering the trailer.

## COATING CARE AND CORROSION PREVENTION

Your Eagle Bridge™ trailer is coated with a high-performance polyurethane paint. This paint is designed to give you durable performance in the rugged environments encountered by your trailer.

The best way to preserve the finish on your trailer and help prevent corrosion is to wash it regularly, especially after it has been used around road salt or other ice melting agents, road oil or tar, or any other potentially corrosive material. Use warm water with a mild detergent and allow the trailer to air dry. Use of abrasive or caustic cleaning agents will void the paint warranty. Hauling corrosive products such as salts and fertilizers will also void the paint warranty.

Small nicks or chips in the paint can occur with normal use. Any chips or scratches in the finish should be repaired with matching touch-up paint. This is especially important for carbon steel trailers, as even small areas of bare metal can corrode quickly. The cost of repairing any chips is the responsibility of the owner.

Removal or disrepair of mud flaps on either the tractor or the trailer will void the paint warranty. Frequent use of the trailer on gravel roads will also void the warranty.

If your trailer has aluminum wheels, you should clean them regularly with mild detergent and water to prevent corrosion. Use a non-abrasive, non-acidic cleanser to remove heavy build-up when necessary. Do not use abrasive metal polishes or scouring pads.

## STAINLESS STEEL BODIES

Trailers with stainless steel bodies require the same care as painted trailers. Regular washings to remove road grime and remnant corrosive material will help maintain the finish and help prevent corrosion. Use warm water with a mild detergent and allow the trailer to air dry. Use of abrasive cleaning agents will dull and scratch the finish. Use of carbon steel utensils will result in surface contamination.

It is particularly important to rinse off the trailer after hauling any material containing chlorides as prolonged contact with chlorides may dull the finish and leave it subject to pitting.

Carbon contamination of stainless steel will cause localized rust spots. The breakdown of the carbon on the surface of stainless steel does not affect the structural integrity of the trailer.

## CLEANING THE INTERIOR

If product accumulates underneath the chain and flaps, it can usually be removed by lifting each flap and vacuuming, sweeping or blowing the material out. **Under no circumstances should you get into the trailer with the conveyor system running or enabled (Figure 14). For your safety, completely disable the hydraulic system before entering the trailer (Figures 15 and 16).**



Figure 14 - Entry into Trailer Decal

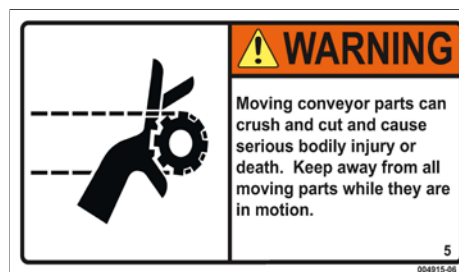


Figure 15 - Moving Conveyor Parts Decal

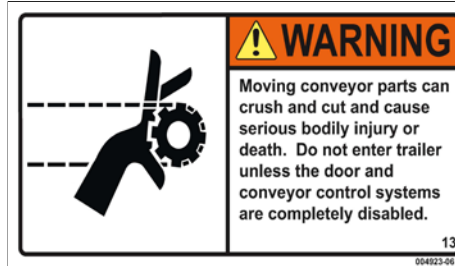


Figure 16 - Moving Conveyor Parts Decal

## SPRING SUSPENSION INSPECTION AND MAINTENANCE

### SPRING SUSPENSION INSPECTION

The following are Hutchens Industries' instructions for suspension inspections. Trinity Trailer Manufacturing requires you to show proof of compliance with these instructions prior to providing any warranty service.

The first maintenance check should be performed after an initial break-in-period of about 1,000 miles. A visual inspection of all suspension components and attachment welds should be performed to reveal any obvious problems, such as cracks or unexpected wear.

During this "walk-around", it is essential to also check the torque on all suspension fasteners. In the course of the initial "shake down" period in which the components of the suspension "seat in", as much as 25% of the original clamp load of the bolted fasteners can be lost. After the parts of the suspension have worked together for a very short period of time, re-torquing the bolts is necessary to ensure that undue movement, which results in excessive wear, does not occur.

Visual inspections and re-torquing are maintenance procedures that are performed every four months throughout the life of the trailer.

Begin each inspection with a review of the Hutchens torque decal for the appropriate torque values for each suspension fastener, Figure 17 (the decal can be found on the road side of the trailer and is shown for your convenience). The oiled torque values in the first column are for new fasteners with lubricated threads. When you are installing new components, we recommend you lubricate the threads and use torque values in this column. For maintenance checks on fasteners that have been in service, use the higher torque values in the dry thread column. It's important that you check all bolts and nuts to insure that the recommended torque values are being maintained. You cannot rely on your visual inspection to detect loose fasteners. **USE A TORQUE WRENCH!**

**WARNING**

**SAFETY ALERT! (1) FOLLOW ALL TORQUE REQUIREMENTS. (2) DO NOT USE ANY COMPONENT WITH VISIBLY WORN OR DAMAGED THREADS. FAILURE TO FOLLOW THESE SAFETY ALERTS CAN LEAD TO LOSS OF VEHICLE CONTROL, PROPERTY DAMAGE, SERIOUS PERSONAL INJURY OR DEATH.**

**Hutchens Suspension Torque Requirements**  
**9600-9700 Series ( Decal Part Number 16086-01 Rev. J )**

After an initial break in period, approximately 1000 miles, and at least every 4 months periodically thereafter, ALL bolts and nuts should be checked to insure that recommended torque values are being maintained.

Oiled torque values listed are for new fasteners with lubricated threads. It is recommended that new installations be performed with oiled fasteners. For dry threads which have been in service, use the higher torque values which are noted below.

	OILED	DRY
1 1/8-7 ( 9600 / 9700 Rocker Bolt ) .....	590 lb-ft	790 lb-ft
1-14 or 1-8 ( 9700 Radius Rod Bolt ) .....	540 lb-ft	720 lb-ft
7/8-14 ( Axle U-Bolts & 9600 Radius Rod Bolt ) .....	350 lb-ft	470 lb-ft
3/4-16 ( Axle U-Bolts ) .....	310 lb-ft	420 lb-ft
5/8-18 ( Radius Rod Clamp Bolt ) .....	130 lb-ft	170 lb-ft
5/8-18 ( Spring Retainer Bolt ) .....	35 lb-ft	50 lb-ft

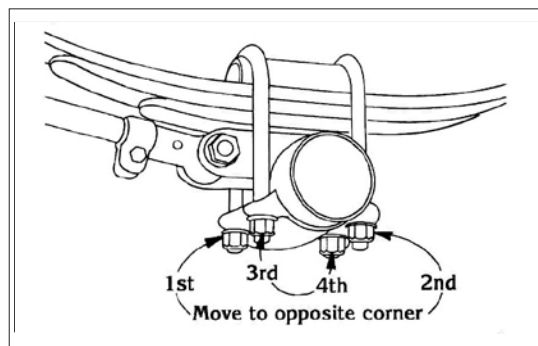
Hutchens Industries, Inc., P.O. Box 1427, Springfield, Missouri 65801-1427 Toll Free 1 (800) 654-8824

**Figure 17 -Spring Suspension Torque Requirements**

**AXLE CLAMPS AND SPRINGS**

Check the torque on the U-bolt nuts by alternately tightening opposing corners of the clamp assembly, as shown in Figure 18. Dry threads should be tightened to 470 ft-lbs.

Carefully inspect the spring and axle clamp components for any signs of wear or cracks and replace if visible wear or cracks are present.

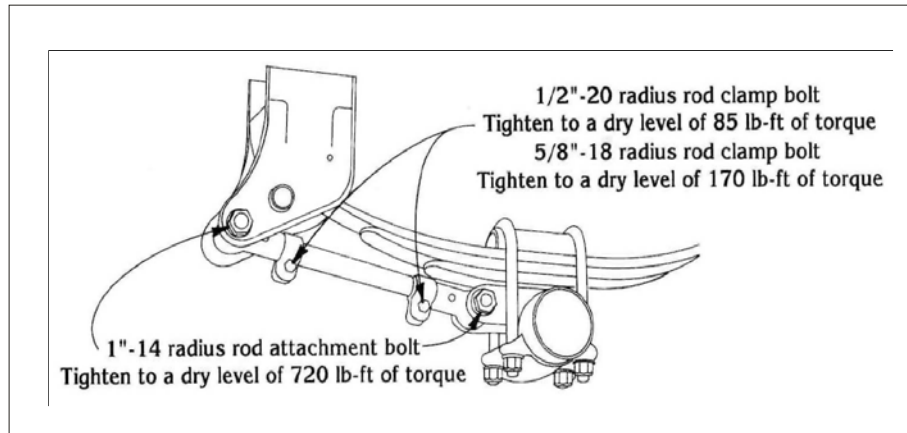


**Figure 18 - Spring Suspension Axle Clamp Tightening Sequence**

## RADIUS RODS

The 1" radius rod attachment bolts (Figure 19) at the hangers and spring seats should be checked for proper torque on both the adjustable and non-adjustable radius rods. Loose operation of this bolt can result in wear, requiring new components to be installed to avoid structural damage. If you observe any visible wear or loosening in the bushing, it is imperative that you immediately replace the radius rod bushing and bolt. Failure to replace these components will result in damage to the hanger, spring seat and/or the radius rod.

Next, check the radius rod clamp bolts (Figure 19) for proper torque. If the clamp bolt has not been properly maintained, wear between the radius rod screw and the eye end may be observed. If so, the entire radius rod must be replaced. Simply re-tightening the clamp bolt or replacing it will not correct the problem.

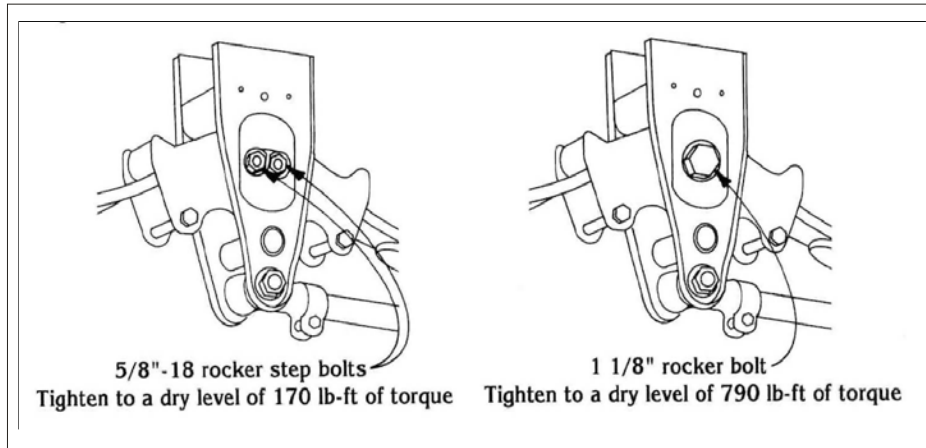


**Figure 19 - Radius Rod Bolts**

## ROCKER BUSHINGS

Check the rocker bushing clamp bolts (Figure 20) for proper torque. If the bolts are loose, you must inspect the rocker to ensure that no structural damage has occurred. One way this can be done is by raising the trailer until the trailer weight is taken off of the springs. If the rocker is displaced or if the joint is loose, the rocker should be removed and the rocker and/or rocker bushings replaced. Again, visually inspect the condition of all the rocker/rocker hanger assembly components and replace if visible wear is present.

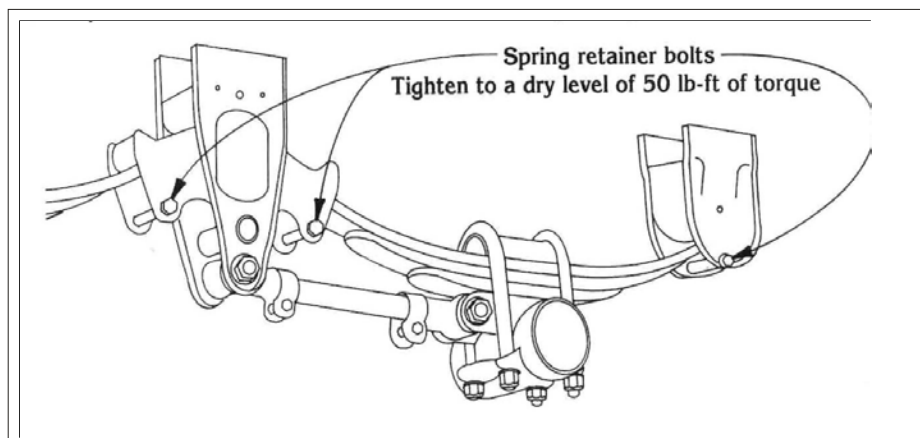




**Figure 20 - Rocker Bushing Bolts**

**HANGERS**

Check all of the spring retainer bolts (Figure 21) found in the rockers and rear hangers. Trailers that are operated with loose fasteners for any period of time will result in irreversible suspension damage and possible loss of vehicle control. **Re-tightening a worn fastener will not correct a situation created by loose operation!**

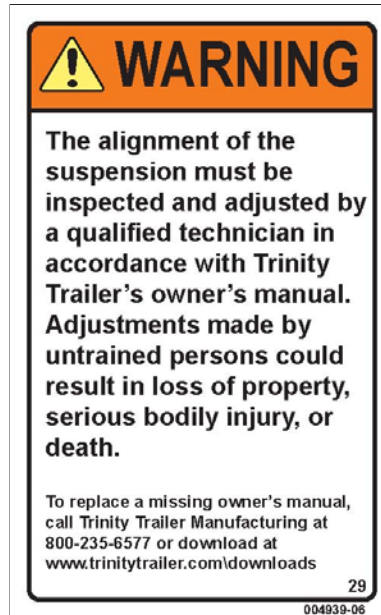


**Figure 21 - Spring Retainer Bolts**

**SPRING SUSPENSION ALIGNMENT**

Trinity Trailer aligns the suspension using industry-standard alignment procedures. After an initial break in period of 1,000 miles, loosened bolts, nuts and springs can affect the alignment. The surface of the road and type of terrain can also affect the suspension alignment.

Proper and preventive maintenance after the initial alignment is the responsibility of the owner/operator. If you have not been properly trained in suspension alignment procedures, have the work done by a qualified technician. Figure 22 shows the decal that was placed on your trailer when it was built.



**Figure 22 - Suspension Alignment Decal**

Trailer axle alignment should be checked (and adjusted if necessary):

- After the initial break-in of 1,000 miles
- Following any maintenance or repair procedures performed on the suspension

Perform the suspension inspection and re-tightening procedures prior to alignment.

The following information is the standard recommendation for suspension alignment. This information is applicable to all trailers with spring suspensions.

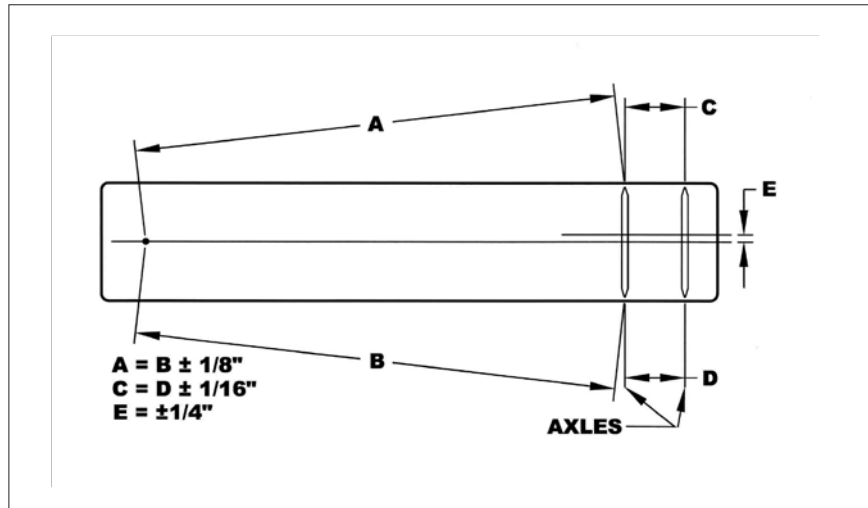
Before the trailer can be aligned properly it must be unloaded. Free the suspension of any binding by pushing the trailer backwards and then pulling forward. The trailer must be level, both side-to-side and front-to-rear. Neither the service nor parking brakes should be applied during the measurement procedure.

The axle position may be determined using any established mechanical or optical (laser) measurement equipment.

Measure distances A and B from the kingpin to the front axle. These dimensions must be within 1/8" of each other. If adjustment is needed, loosen the radius rod clamp bolts and turn the adjustment screw as required. When the front axle is positioned correctly, align any succeeding

axles with the front axle by measuring distances C and D. These dimensions must be within 1/16" of each other (Figure 23).

After the alignment has been completed on all axles, check to make certain the radius rod clamp bolts and all other fasteners are tightened to the required torque.



**Figure 23 - Suspension Alignment Requirements**

## AIR-RIDE SUSPENSION INSPECTION AND MAINTENANCE

### AIR-RIDE SUSPENSION INSPECTION (HENDRICKSON HT SERIES, INTRAAX®, COMPOSILITE™ AND INGERSOLL ISS SERIES)

#### DAILY

Verify that the trailer is level and riding at the correct height.

#### EVERY 30 DAYS

Review the clearances around the air springs, tires, shock absorbers and all other moving parts. Bolts should be secure and axle connections tight. Any signs of wear should be evaluated and corrected as necessary.

#### EVERY 90 DAYS

In addition to the above, inspect all welded connections, frame attachment joints, cross member structures and all pivoting and clamping connections.

## HENDRICKSON SUSPENSION TORQUE REQUIREMENTS

The following torque values (Figure 24) are applicable to both the HT Series and INTRAAX® air suspensions. A decal similar to Figure 25 will appear on trailers with an INTRAAX® suspension.

COMPONENT DESCRIPTION	FT-LBS	N•M
Air Spring Bolts, Lower (HT Series, AAEDT 30K, AAEDL 30K and HRRNT 40K / HRRNT 50K)	45±5	61±6
Air Spring Nut, Lower (INTRAAX® and VANTRAAX®)	58±2	79±2
Air Spring Nuts, Upper (¾ inch)	90±10	125±10
Air Spring Nuts, Upper (½ inch)	45±5	61±6
Body Rail Clip Bolt	100±10	135±12
Brake Chamber Mounting Nut (INTRAAX®)	105±5	145±4
Hubcap Mounting Bolts	15±3	21±3
Lift Mechanism Air Spring, Actuator (¾ inch)	50±5	70±4
Lift Mechanism Air Spring, Actuator (⅝ inch)	18±2	25±2
QUIK-ALIGN® Pivot Connection	550±45	750±50
S-Cam Support Bearing Mounting Nut (INTRAAX®)	40±5	55±6
Shock Bolts	225±10	300±10
U-Bolts (HT Series)	500±25	680±30
Welded Pivot Connection (1 ⅛ inches)	800±25	1085±30

COMPONENT DESCRIPTION	IN-LBS	N•M
ABS Bracket Bolt and Nut (INTRAAX®)	90±10	11±0
Disc Brake Dust Shield Clamp	60±10	7±0
Drum Brake Dust Shield Clamp	110±15	13±1
Height Control Valve Mounting	70±10	8±1

**Figure 24 - Hendrickson Torque Specifications**

### NOTE

**Torque values are specified for the fasteners in the condition in which they were supplied by Hendrickson. Do not apply any additional lubricants.**



Over-torquing could result in fastener failure which could lead to a crash. Do not tighten the fasteners beyond the recommended torque.

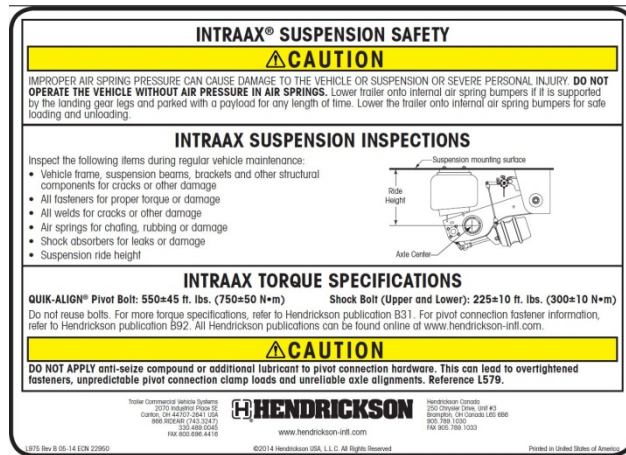


Figure 25 - INTRAAX® Decal

**COMPOSILITE™ TORQUE REQUIREMENTS**

The following torque values are for the Composilite™ auxiliary lifetable axle (Figure 26).

DESCRIPTION	SIZE	TORQUE (ft. lbs.)
Pivot Bolt	7/8"	450
Axle Attachment	3/4"	380
Stabilizer Attachment	3/4"	75
Frame Attachment	3/4"	420
Cross Member Attachment	1/2"	80
Air Spring Bolt (Bottom)	3/8"	25
Air Spring Nut (Top)	1/2"	25
Air Spring Nut (Top)	3/4"	45
Tie Rod Clamp Bolt Nut	1/2"	50
Tie Rod U-bolt	3/8"	20
Axle Stop Bolts	1/2"	45

Figure 26 - Composilite™ Torque Specifications

**NOTE**

**Torque values are specified for the fasteners in the condition in which they were supplied by Hendrickson. Do not apply any additional lubricants.**



Over-torquing could result in fastener failure which could lead to a crash. Do not tighten the fasteners beyond the recommended torque.

## ISS SERIES TORQUE REQUIREMENTS

The following torque values (Figure 27) are for the ISS Series air suspensions. A decal similar to Figure 28 will appear on trailers equipped with ISS Series suspensions.

FASTENER	Ft-lbs	N-m
1-1/8" - PIVOT BOLT LOCK NUT	900-920	1220-1290
7/8" - PIVOT BOLT LOCK NUT	425-440	575-595
3/4" - SHOCK ABSORBER LOCK NUT	150-175	205-240
1/2" - LOWER AIR SPRING BOLT	25-30	28-40
3/4" - UPPER AIR SPRING NUT	40-45	55-60
1/4" - AIR VALVE & LINKAGE NUT	5	7
3/8" - LOWER AIR SPRING BOLTS – LIFT AS	15-20	20-25
5/8" – BOLT-ON CROSS MEMBER LOCK NUT	160-175	215-240

Figure 27 - INGERSOLL ISS Series Torque Requirements

**SUSPENSION TORQUE REQUIREMENTS**

ITEM	Ft•Lbs	N•m
1-1/8" PIVOT BOLT LOCK NUT BOULON DE PIVOT ECROU	900 - 920	1220 - 1250
7/8" PIVOT BOLT LOCK NUT BOULON DE PIVOT ECROU	400 - 425	540 - 575
3/4" SHOCK ABSORBER LOCK NUT ECROUS DE L'AMORTISSEUR	150 - 175	200 - 240
3/8" AIR SPRING NUTS ECROUS DE BALLON	15 - 20	20 - 25
1/2" AIR SPRING NUTS ECROUS DE BALLON	25 - 30	28 - 40
3/4" AIR SPRING NUTS ECROUS DE BALLON	40 - 45	55 - 60

**⚠ WARNING**

- ✓ All torque values are with clean and dry fasteners and should only be verified with a quality-calibrated wrench of known accuracy.
- ✓ Failure to follow these recommendations could void the warranty.
- ✓ Failure to maintain the specified torque values and/or to replace worn parts, can cause component and/or system failure resulting in an accident with consequent injury.
- ✓ Le serrage doit être fait avec les écrous et boulons sans huile et devrait être vérifié avec une clef dynamométrique.
- ✓ Votre garantie peut être annulée si vous ne suivez pas ces recommandations.
- ✓ La négligence de maintenir le serrage spécifié ou de ne pas remplacer les morceaux défectueux peut causer des dommages et des accidents.

**CHECK TORQUES AFTER 1000-3000 MILES AND THEN RE-CHECK ANNUALLY  
VÉRIFIEZ LES COUPLES APRÈS 1000-3000 MILLES ET PUIS LES REVÉRIFIEZ ANNUELLEMENT**



AN IMT COMPANY™

347 King Street West, Ingersoll, Ontario, Canada, N5C 3K5  
Phone: (519) 485-2210, Fax: (519) 485-6336  
www.ingersollaxles.com

DECAL TORQUE REV™

Figure 28 - INGERSOLL ISS Series Decal

**NOTE**  
**TORQUE VALUES ARE WITH CLEAN AND DRY FASTENERS**

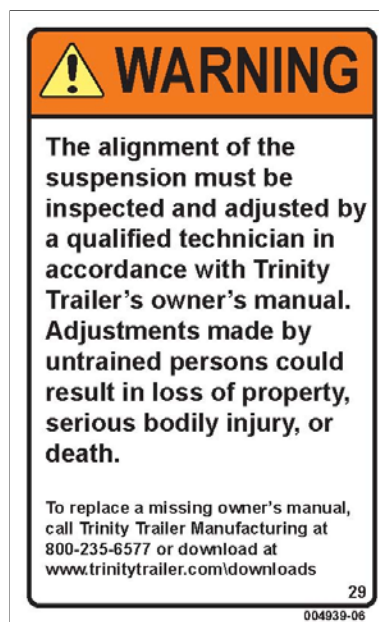


Over-torquing could result in fastener failure which could lead to a crash. Do not tighten the fasteners beyond the recommended torque.

## AIR-RIDE SUSPENSION ALIGNMENT

Trinity Trailer aligns the suspension using industry-standard alignment procedures. After an initial break-in period of 1,000 miles, loosened bolts, nuts and springs can affect the alignment. The surface of the road and type of terrain can also affect the suspension alignment.

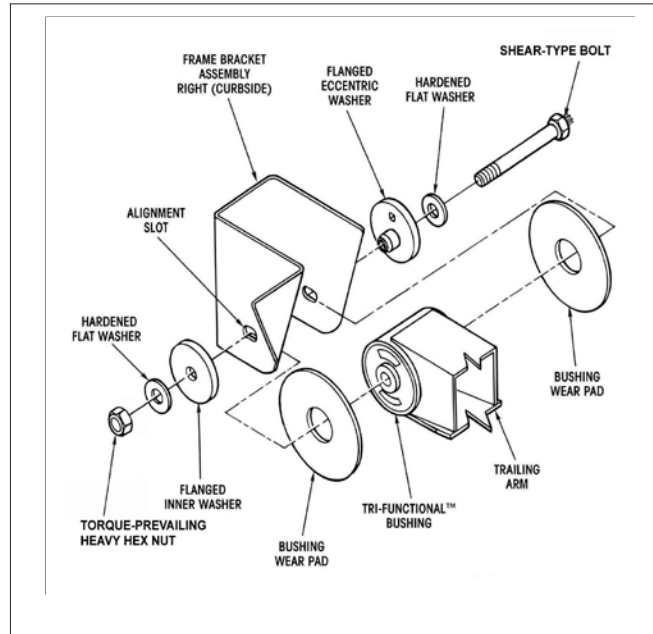
Proper and preventive maintenance after the initial alignment is the responsibility of the owner/operator. If you have not been properly trained in suspension alignment procedures, have the work done by a qualified technician. Figure 29 shows a decal that was placed on your trailer when it was built. See Figure 23 (pg.21) for the suspension alignment requirements.



**Figure 29 - Suspension Alignment Decal**

## QUICK-ALIGN® CONNECTION

Hendrickson suspensions use a non-welded Quick-Align® feature (Figure 30). The following guidelines must be used when aligning an air-ride suspension.



**Figure 30 - Air-ride Suspension Alignment Components**

1. Remove and discard the pivot bolts and nuts on the forward axle connections and replace with new shear-type bolts and torque-prevailing nuts. Tighten the nuts on the pivot bolts to hold the flanged washers in place against the adjustment guide, but loose enough to permit the hardened flat washers to rotate freely.



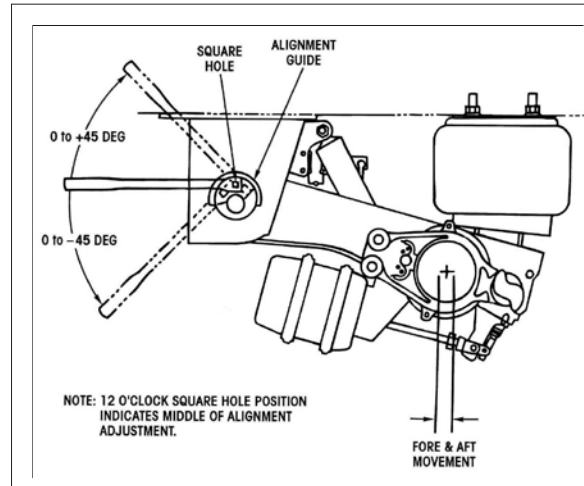
Do NOT re-use the pivot joint fasteners. A new pivot bolt and shear-type bolt must be installed to prevent pivot connection failure due to insufficient clamp load. These parts are contained in Hendrickson kit S-24679, available from our parts department. No liability is assumed for pivot joint failures when either a shear-type bolt or torque-prevailing nut is reused.



Do not apply or allow any type of lubricant to contact the threads of pivot connection fasteners. Lubricant will reduce the friction between the threads of the pivot fastener and nut. Failure of the pivot fastener could occur.

2. On the previously mentioned pivot connection, inspect the orientation of the square hole (Figure 31) on the eccentric flange washer (outboard side). The square hole should be at the 12 o'clock position (middle of the alignment adjustment); adjust if necessary. To adjust the eccentric, insert a ½" square drive breaker bar into the square hole on the eccentric flanged washer. Rotating the eccentric flanged washer clockwise (45° maximum) or counterclockwise (45° maximum) will provide fore and aft positioning.





**Figure 31 - Air-ride Suspension Alignment**

3. Repeat step 1 and 2 on the remaining connections.
4. Follow the measurement steps in the spring suspension alignment process above.
5. If additional axle movement is necessary, adjust the eccentric washer on the opposite side of the forward axle from the 12 o'clock position.

**NOTE**

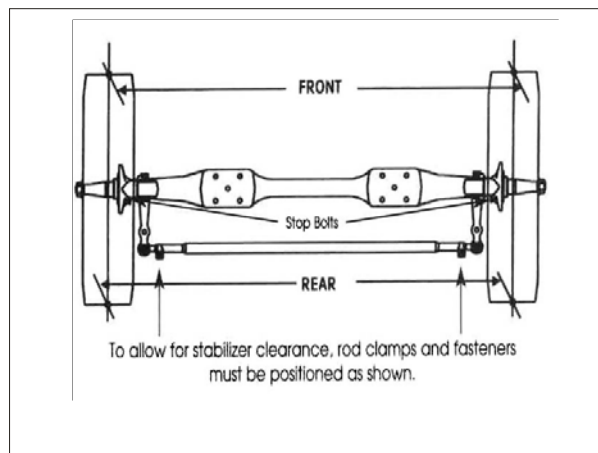
**Be sure that the axle movement occurs without compressing the Tri-Functional™ Bushing.**

6. After achieving proper alignment of the forward axle, snug the pivot connections and recheck alignment.
7. Apply torque to the torx-head portion of the shear-type bolt until it shears off of the hex head.
8. Align additional axles to the forward axle by rotating their eccentric flanged washer(s) until both ends of the axle are an equal distance from the front axle (see Figure 23 pg.21). Repeat steps 1, 2,3,5,6 and 7.

## COMPOSILITE™ ALIGNMENT

Only the toe setting needs to be checked on the Composilite™ auxiliary axle.

1. Lift the axle until the tires are free to spin. Make a line around each tire at the center of the tread using a paint marker.
2. Use a measuring tape to measure the distance between the lines at the front and rear of the tires at the same height as the axle.
3. If the distance between the lines is 1/16" to 1/8" at the front (toe-in condition), no adjustment is necessary.
4. If the measurements do not meet the above requirements, loosen the tie rod clamp bolts, stabilizer mounting U-bolts (if applicable) and nuts. Rotate the tie rod tube until there is a toe-in setting of 1/16" to 1/8" (see Figure 32).
5. Tighten and torque the hardware to the specifications given in Figure 17.

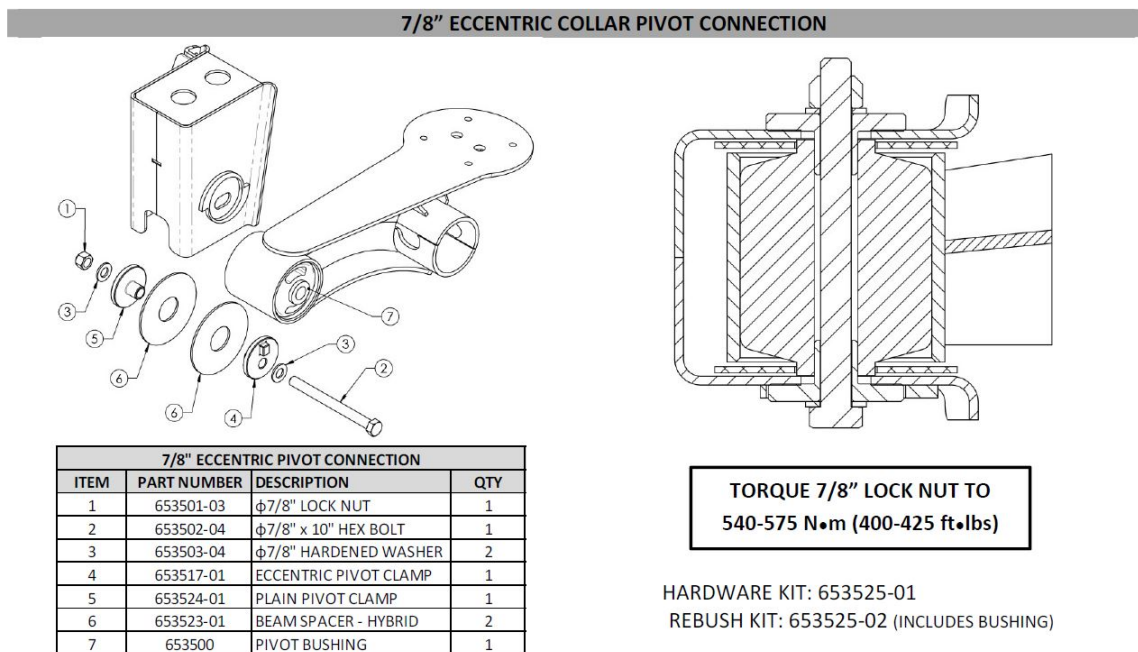


**Figure 32 - Composilite™ Alignment**

## INGERSOLL ISS SERIES ALIGNMENT

INGERSOLL ISS SERIES suspensions use a non-welded eccentric collar pivot connection (Figure 33). The guidelines in Figure 34 must be used when aligning an ISS Series air-ride suspension.

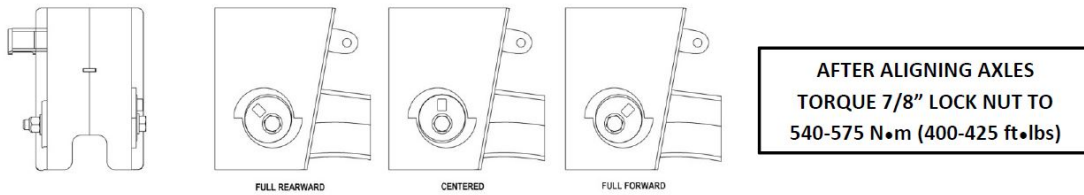
Follow the measurement steps in the spring suspension alignment process above (Figure 23 pg.21).



**Figure 33 - ISS Series Eccentric Collar Components**

**ECCENTRIC COLLAR PIVOT CONNECTION**

The Eccentric Collar style pivot connection uses two flanged collars inserted into slots on each side of the hanger. The eccentric collar on the outboard side of the hanger is used to adjust the position of the axle during an alignment. The alignment guide on the outboard side of the hanger limits the eccentric collar to rotational movement in the hanger slot. Rotating the eccentric collar clockwise or counter clockwise causes the axle to move forward or rearward respectively. If proper torque is maintained, no welding of this style of pivot connection is required.

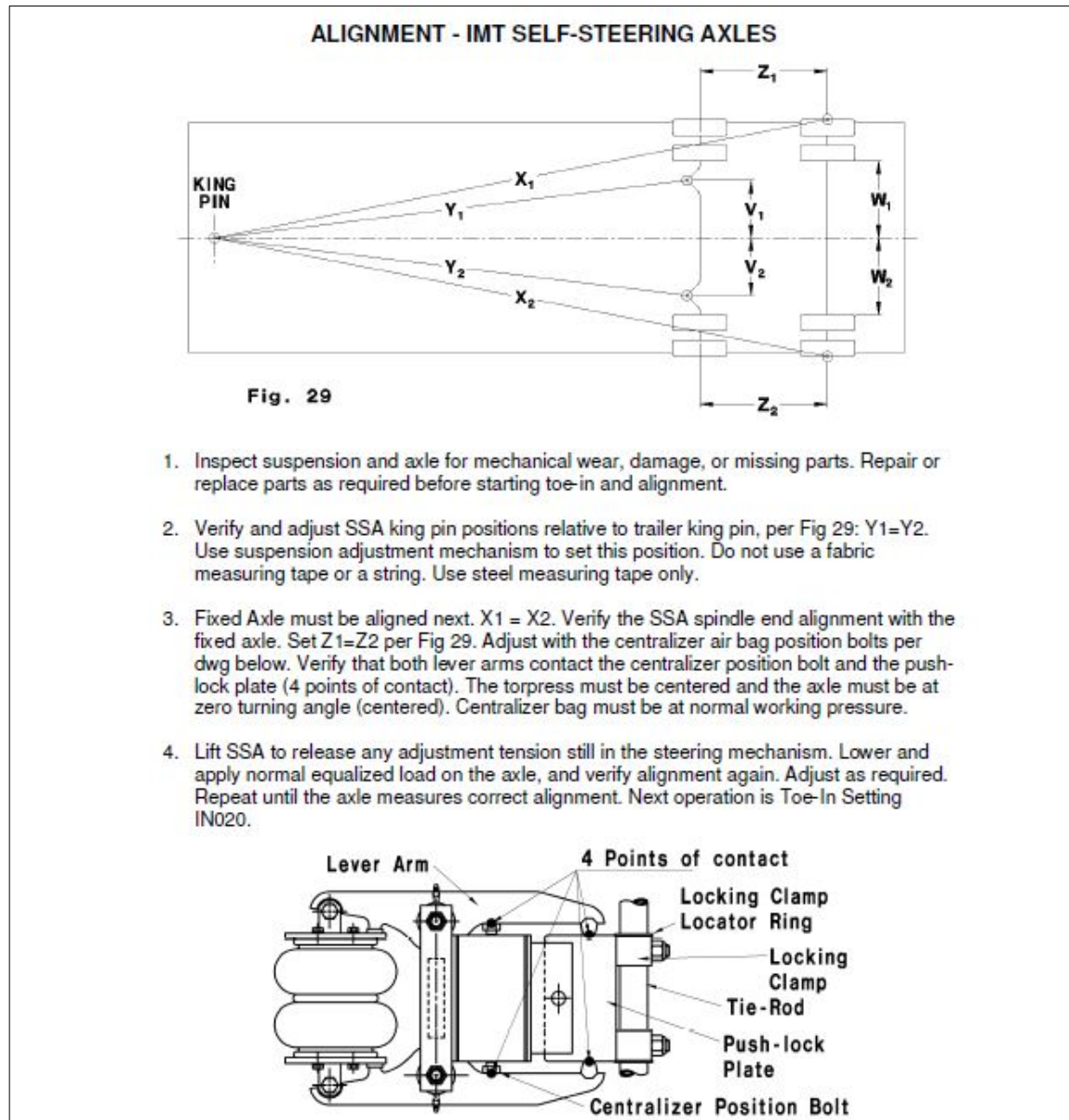


**WARNING:** The eccentric collar must remain flat against the hanger throughout the alignment process. If the pivot connection fasteners are too loose, the eccentric collar may raise up on the alignment guide and become wedged or raised. This will result in an improper alignment. This can be avoided by tapping on the inboard side of the hanger while adjusting the outer eccentric collar.

**Figure 34 - ISS Series Alignment Guidelines**

## INGERSOLL ISS SERIES SSA (SELF-STEERING AXLE) ALIGNMENT

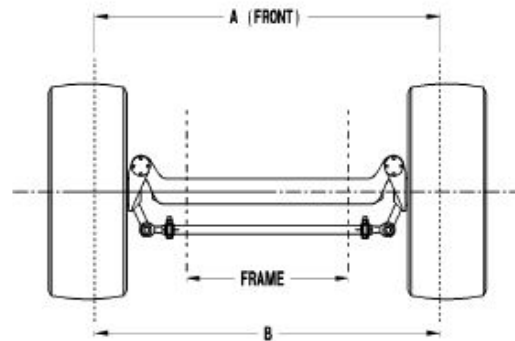
The following Figures 35, 36 and 37 are extracted from the INGERSOLL AXLES INSTALLATION AND MAINTENANCE MANUAL for axles.



**Figure 35 - IMT Self-Steering Alignment Procedure**

**PROCEDURE IN020**  
**P-1/2**  
**IMT Self Steer Axle (700000 Series)**  
**TOE-IN ADJUSTMENT**

September 28, 2011



1. Tires must be of the same size, pressure, and tread pattern. Hubs, drums and brakes must be identical. All suspension bushings and parts must be in good mechanical order and correctly adjusted.
2. Scribe a fine line on the tire tread all around the tire.
3. Measure between the scribed lines on tires in front and on the back, on axle center line. "A" is always measured in front, when axle/suspension is normally loaded. "B" is always measured behind the axle. See "Toe-in/out" Chart and Drawing P2/3 for correct toe setting.
  - a. TOE-IN: "A" is smaller than "B".
  - b. TOE-OUT: "A" is larger than "B".
4. Adjust by rotating the tie-rod with axle un-loaded. Tie-rod ends must be square with stud, and guide plate must be centered in u-bracket before tightening the clamps. Tighten all the clamp bolts and the tie-rod end nuts to 150/200 ft-lbs. of torque.
5. Check toe-in after each adjustment until the axle is within specification.

**WHEN TO CHECK TOE-IN**

1. Before releasing all new installations.
2. Whenever the vehicle experiences unusual vibration or when the axle is unstable.
3. When tires experience unusual edge wear.
4. Each time new tires are installed.
5. Each time the tractor steering is aligned.
6. Each time repairs are done to the axle.

**Figure 36 - IMT Self-Steering Axle Toe Adjustment p.1**

**PROCEDURE IN020**

September 28, 2011

P-2/2

**Toe-In/Out Setting for IMT SSA**

SSA Axles Toe-in/Toe-out changes from unloaded to loaded condition due to normal flexing of the axle and suspension components. Setting Toe values will be affected by load and tie-rod height position.

**Recommended Toe-In LOADED: 1/16", (+1/16", - 0")**

When loaded, all SSA should have 1/16" (+1/16", -0") toe-in.

**Recommended Toe-In UNLOADED varies with Tie-Rod Height:**

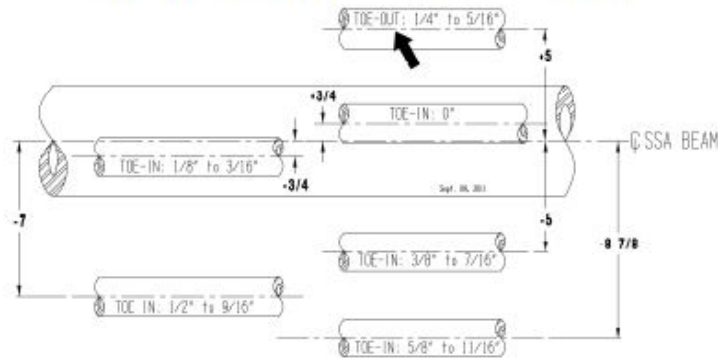
When setting the toe UNLOADED, please follow guide below.

Note: Plus 5" tie-rod position requires TOE-OUT.

Tie-Rod Height	Toe Setting	TOE Direction
+ 5"	1/4" to 5/16"	Toe-Out
+ 3/4"	0"	Toe-In
- 3/4"	1/8 to 3/16"	Toe-In
- 5"	3/8"to 7/16"	Toe-In
- 7"	1/2 to 9/16"	Toe-In
- 8 7/8"	5/8 to 11/16"	Toe-In

**SSA should be lifted/raised when unloaded.**

**TOE-IN / TOE-OUT VALUES (UNLOADED)  
\*\*SET ACCORDING TO TIE-ROD HEIGHT\*\***



**\*\*\*LOADED TOE-IN SHOULD BE 1-16", +1-16" -0"\*\*\***

**Figure 37 - IMT Self-Steering Axle Toe Adjustment p.2**

## HUB AND WHEEL INSTALLATION AND MAINTENANCE

In addition to following the instructions below, it is recommended that you read and understand the federal regulations relating to tire and wheel handling and maintenance. A copy of these can be obtained through the U.S. Government printing office, your local library or the internet. Refer to 29 CFR 19103177, *Servicing Multi-Piece and Single Piece Rim Wheels*.



**Figure 38 - Wheel Hardware Decal**

### PILOT MOUNT WHEELS

Pilot mount wheels have stud holes that are reamed straight through the wheel. Pilot bosses machined on the hub fit tightly to the center hole of the wheel. Pilot mount wheels are secured with right-hand thread flange nuts on studs which have at least 2.16" standouts. This mounting method is also commonly referred to as "hub piloted".



Follow the information below when working the wheels on your trailer. Failure to do so can lead to loose wheels or component failure, resulting in loss of property, serious bodily injury or death. See Figure 38.



- Use correct, matched parts when mounting the wheels.
- Do not combine ball seat mount wheels (described above) with pilot mount wheels.
- Do not use ball seat nuts with pilot mount wheels.
  
- Do not use heat to remove frozen flange nuts. This could result in a component failure.
- Only use tires that are within 3/4" of the same rolling circumference. Greater difference in circumferences can cause unstable operation and reduce component life.
- Tighten the flange nuts in the proper sequence and to the required torque.

### Mounting Pilot Mount Wheels (Figure 39)

1. All parts must be clean and free of rust, dirt or paint.
2. Position the inner wheel over the studs, being careful not to damage the threads.
3. Position the outer wheel over the studs, being careful not to damage the threads.
4. Install the flange nuts and tighten to 50 ft-lbs in the sequence shown below.
5. Make sure the surface of the wheel which is contacted by the flange nut is flat.
6. Tighten the nuts to 450-500 ft-lbs using the same sequence.

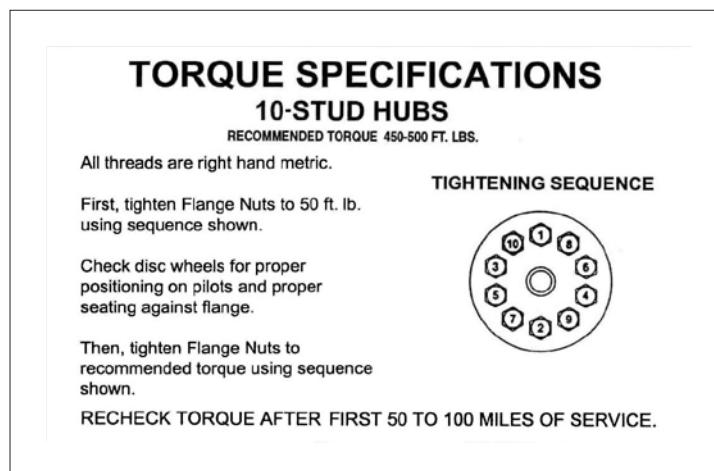


Figure 39 - Pilot Mount Wheel Torque Specifications

**NOTE**  
**The torque listed is for dry threads with no lubricant. Proper flange nut torque is important. Insufficient torque can cause stud breakage and damages the ball seats. Excessive torque can overstress the studs and strip the threads.**



The flange nuts must be re-tightened after the first 50 to 100 miles of service. Tighten them to 450-500 ft-lbs in the sequence shown above. Failure to re-torque the flange nuts could result in the wheel becoming loose on or falling off of the trailer during operation resulting in property damage, personal injury or death.

**RECOMMENDED PROCEDURE FOR REPLACING STUDS**

- When a broken stud is replaced, the stud on each side of it should also be replaced.
- If more than two studs are broken, replace all of the studs.
- Use the correct stud size. If the correct length stud is not used, the back nut (jam nut) may not seat firmly against the drum.
- Too much “standout” from the mounting face of the hub may make it impossible to secure the inner wheel against the hub face (ball seat mount wheels).
- If replacing studs on ball seat mount wheels, remember that right-hand studs go on the right-hand side (curbside) of the vehicle and left-hand studs go on the left-hand side (roadside).

**HYDRAULIC SYSTEM SERVICING**

**TRACTOR HYDRAULIC SYSTEM REQUIREMENTS**

<u>Gear Pump Requirements (Volume):</u>	10-20 GPM (Gallons per Minute)
<u>Reservoir capacity:</u>	Minimum 5 Gallons
<u>Hyd. Pressure Requirements/Bypass Settings:</u>	2500 PSI/3000 PSI

Tractor hydraulic oil must be maintained at all times. Neglect of the tractor oil will result in premature hydraulic component failure. Pressure line filters are optional.

If the trailer was ordered with "Food Grade" hydraulic oil the tractor must also have "Food Grade" hydraulic oil or it will contaminate the trailer's hydraulic system.

The trailer is rated for a maximum 25 GPM. If your tractor produces more than 25 GPM we offer an optional flow divider valve that will allow 25 GPM to the trailer controls and return the excess flow back to the tractor.

**PRESSURE FILTERS**

Trailers with a PTO unload system will have an inline pressure filter mounted near the landing legs.(Figure 40) The filter has a sight glass on top of the housing unit that indicates the condition of the filter. If the sight glass shows red while the PTO is engaged, it is time to replace the cartridge inside of the filter. These filters DO NOT have a bypass. As the filter becomes clogged, it will slow down the flow of oil which will slow the unloading of the product.

Contact our parts department toll free at 800-235-6577 to order a replacement filter. (Figure 41)



**IF THE TRACTOR IS NOT EQUIPPED WITH A PRESSURE RELIEF VALVE, A CLOGGED FILTER CAN CAUSE AN OVERPRESSURE SITUATION THAT CAN DAMAGE HYDRAULIC HOSES AND PUMPS**



**Figure 40** - Pressure Filter Location

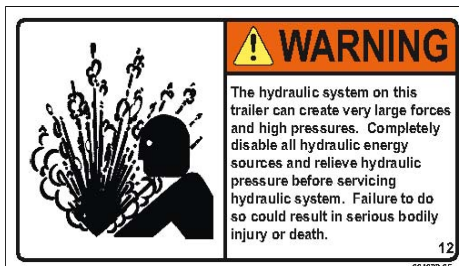


**Figure 41** - Pressure Filter Part Numbers

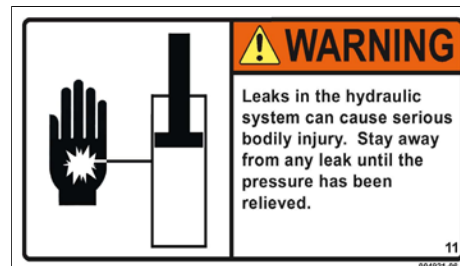
## HYDRAULIC CYLINDER MAINTENANCE

The hydraulic cylinder which operates the rear door(s) (if installed) should be inspected before each use. See Figures 42 and 43 for precautionary measures that must be taken before performing any maintenance.

- Repair any leaking fittings found before operating the cylinder.
- Keep the cylinder clean and free from foreign materials.
- If there is leakage across the cylinder or the cylinder housing or the shaft is damaged, replace the cylinder.
- A light film of oil on the shaft of the cylinder is normal and should not be mistaken as a leak.
- Small burrs or scratches should be removed from the shaft using a honing stone or emery cloth before use of the cylinder.



**Figure 42** - Hydraulic System Pressure Decal



**Figure 43** - Hydraulic Leak Decal

## HYDRAULIC LINES AND FITTINGS

Visually inspect the hoses and fittings for leaks, cracks, chafing or crimping. Since the hydraulic system operates at high pressures, replace any components which are worn or damaged before use.

## HYDRAULIC FLUID RECOMMENDATIONS

- The hydraulic oil level in the tank should be no lower than four inches from the top which will be at the 80°C of the tank. Check the oil level daily. Refill as required.
- The low pressure filter in the system should be changed after the first 50 hours of operation and every 250 hours thereafter. Under dirty or dusty conditions, change the filter more frequently.
- Recommended fluid-Chevron Hydraulic Oil AW ISO 32 or equivalent. For food grade applications Chevron Hydraulic Oil FM ISO 32 or equivalent may be used.

## GASOLINE ENGINE SERVICING

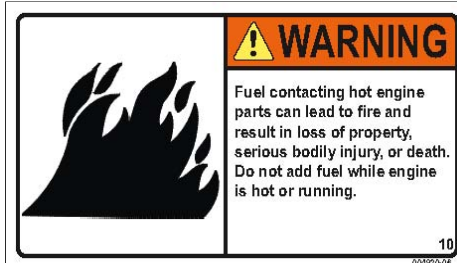
Service the gasoline engine in accordance with the engine owner's manual supplied with your trailer. If you need a replacement copy of the manual, call our parts department at 800-235-6577. The following safety precautions, along with Figures 44 and 45 should be adhered to when working around the gasoline engine (if installed).



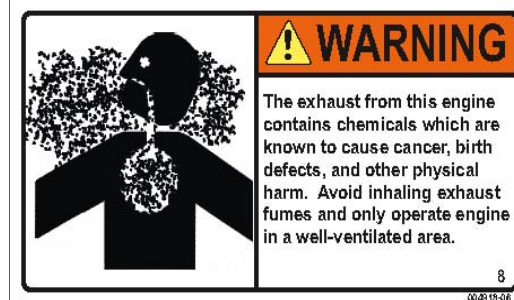
Gasoline engines equipped with electric starters have a 12-volt battery which can be unsafe if handled improperly. Follow these precautions when servicing the battery.

- Use extreme care when servicing the battery. Battery fluid contains sulfuric acid and must be kept away from your eyes and skin. Safety glasses, rubber gloves and protective clothing are needed when handling the battery. If acid contacts your eyes or skin, flush immediately with large amounts of water. Get emergency attention immediately.
- The battery can produce hydrogen gas and can explode, causing serious bodily injury. Do not smoke while checking or servicing the battery. Keep open flames and sparks away from the battery.
- To avoid a short circuit across the battery, which can result in serious bodily injury, never allow tools or metal objects to contact the battery posts and the trailer. Disconnect the negative battery cable when checking or servicing the battery.
- Keep battery fluid away from children and pets.
- Do not store the battery where there is a likelihood of open fire, sparks or accessibility to children.

Some areas require that the engine be equipped with a spark arrester to reduce the potential for the exhaust from the engine to cause a fire. Your engine should have had one installed when the engine was installed on your trailer. You should remove the arrester and clean it in accordance with the engine manual at least once every 100 hours of operation.



**Figure 44 - Refueling Warning Decal**



**Figure 45 - Engine Exhaust Decal**

## **ANTI-LOCK BRAKE SYSTEM (ABS)**

The Meritor WABCO 4S/2M anti-lock brake system is used on your trailer. This system exceeds the requirements of the Transportation Code of Federal Regulations, 49 CFR 571.121.

You should use your brakes as you normally would when you are driving. Apply the brakes the same way you would if your trailer didn't have an ABS system. You should not need to pump the brakes if the system is working properly. You may notice some chassis vibration when excessive brakes are applied. This is normal; the system senses the wheel rotation speed and will modulate the air pressure if it detects a wheel lock-up condition.

**NOTE**  
**Like all anti-lock braking systems, this system will allow a small amount of wheel lock-up.**

Read the following decal (Figure 46) which was supplied by Meritor WABCO and was put on your trailer when it was built.

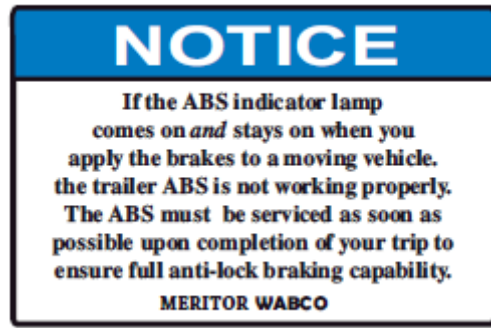


Figure 46 - ABS Indicator Decal

You should note that the vehicle must be traveling at least 5 mph for the light to illuminate. If the light stays on, contact an authorized Meritor WABCO service center to remedy the problem before continuing to operate the trailer.

ABS service must be performed by a qualified technician to ensure the brakes on the trailer operate properly. Read the following decals (Figures 47 and 48) and then follow the instructions and precautions.



Figure 47 - ABS Servicing Decal

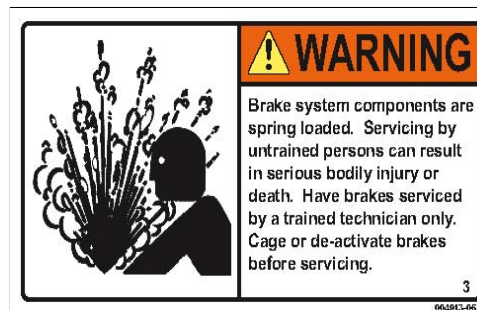


Figure 48 - Brake System Component Decal

## IGNITION POWER ACTIVATION

Ignition Power Activation is the process of using the vehicles ignition switch (or interrupting the power on the blue wire by some other means) to display blink codes on the trailer ABS indicator lamp located on the side of the trailer. This method is for constant power vehicles only.

To obtain blink codes using ignition power activation, perform the following procedure:

1. Turn the ignition switch on for no longer than 5 seconds. The ABS indicator lamp will be on.
2. Turn the ignition switch off. The ABS indicator lamp will go out.
3. Turn the ignition switch on. The ABS indicator lamp will then come on, and then go out.
4. The blink code will be displayed three times by the ABS indicator lamp on the trailer.

BLINK CODES		
Blink Code	Problem Area	Action
3	Sensor BU1	Determine sensor location. Check sensor installation. Make necessary repairs.
4	Sensor YE1	Determine sensor location. Check sensor installation. Make necessary repairs.
5	Sensor BU2	Determine sensor location. Check sensor installation. Make necessary repairs.
6	Sensor YE2	Determine sensor location. Check sensor installation. Make necessary repairs.
7	External ABS Modulator Valve	Verify proper electrical installation. Check power supply. Make necessary corrections.
9	Internal Modulator Failure-inlet valve #2	Verify proper installation. If code continues, contact Meritor WABCO for assistance.
10	Internal Modulator failure-inlet valve #1	Verify proper installation. If code continues, contact Meritor WABCO for assistance.
11	Internal Modulator failure-outlet valve	Verify proper installation. If code continues, contact Meritor WABCO for assistance.
14	Power Supply	Verify proper electrical installation. Check power supply. Make necessary corrections.
15	ECU Failure	Verify proper installation. If code continues, contact Meritor WABCO for assistance.
16	SAE J1708 Failure	Internal failure, contact Meritor WABCO
17	SAE J2497 (PLC) Failure	Internal failure, contact Meritor WABCO
18	Generic I/O Failure	Verify proper electrical installation. Check power supply. Make necessary corrections.

**NOTE:** For ignition power activation, power is provided by the ignition switch.

## REAR IMPACT GUARD

Your trailer meets the latest rear impact guard requirements of the Transportation Code of Federal Regulations, 49 CFR 571.223 and 571.224. Some trailers will have a rear impact guard and some will have a narrow bumper. If the rear impact guard is damaged, the Federal Highway Administration requires that it be repaired such that it will again be in compliance with these regulations in a “like new” condition. Have a qualified mechanic inspect any damage before

continued use of your trailer. Contact our repair department toll free at 800-235-6577 if the guard needs to be repaired.

## OPERATING INSTRUCTIONS

### COUPLING THE TRAILER

To couple the trailer to the tractor safely, follow the procedures below. Figure 49 is warning label placed on your trailer when it was built and relates to the safe coupling of the trailer.



**Figure 49 - Coupling Decal**

1. Check the kingpin and surrounding area for cracks or damage.
2. Clean and lubricate the fifth wheel in accordance with the tractor manufacturer's recommendations.
3. Position the fifth wheel for coupling with the plate tilted down toward the aft end of the tractor, the jaws opened, and the safety unlocking handle in the automatic lock position. If the tractor is equipped with a sliding fifth wheel, lock it in place.
4. Ensure the spring brakes are applied on the trailer.
5. Make certain the doors are securely closed on the trailer.
6. Align the tractor with the front of the trailer and back up until the fifth wheel just touches the trailer.
7. Engage the parking brake and shift the tractor into neutral.
8. Adjust the height of the landing legs so the trailer is level with the fifth wheel.
9. Check to make certain that the kingpin is aligned properly with the fifth wheel.
10. Connect the service and emergency air lines from the tractor to the glad hands on the front of the trailer. Secure the airlines so they will not be damaged when the tractor is backed up under the trailer.
11. Apply the trailer parking brakes by pulling the trailer brake knob in the tractor.
12. Release the tractor brakes by pushing in the tractor brake knob.
13. Back the tractor slowly under the trailer until the kingpin engages in the fifth wheel and locks in place.
14. Raise the landing legs slightly off the ground and pull on the trailer gently with the tractor while the trailer brakes are still locked in the cab to ensure the kingpin is fully engaged.

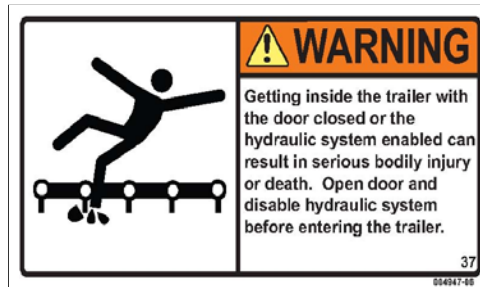


15. Inspect the fifth wheel area thoroughly to make certain the connection between the tractor and trailer is secure. Make certain that the locking lever is in the locked position.
16. Attach the electrical cable from the tractor to the trailer, making sure the connector securely engages the socket.
17. Make certain the airlines and electrical cable are supported to prevent them from chafing or being snagged while connected.
18. Raise the landing legs completely, leave in gear and securely place the crank in its bracket.

**No one should ever be allowed to ride on or in the trailer while it is being towed or has the door closed and/or hydraulic system enabled (Figure 50 and 51).**



**Figure 50 - Riding in Trailer Decal**



**Figure 51 - Getting inside Trailer Decal**

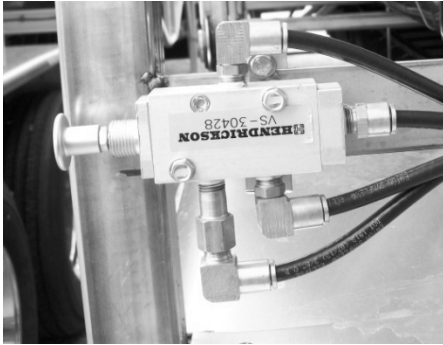
1. Before uncoupling the trailer, move the truck to an area with a level surface capable of supporting the weight of the trailer.
2. Stop the truck with the tractor aligned with the trailer.
3. Lock the trailer brakes and back the tractor up slightly to relieve the pressure on the locking jaws. Engage the parking brake on the tractor.



**WARNING**

If uncoupling from a loaded trailer that is air ride equipped dump air from suspension before continuing (Figure 52, Figure 53 or Figure 66 pg.49)

4. Lower the landing legs until they contact and just start to put pressure on the ground.
5. Disconnect the airlines and electrical cable from the trailer.
6. Move the locking lever on the fifth wheel to the open position.
7. Pull the tractor forward to disengage the kingpin. Stop the tractor before the fifth wheel comes out completely from underneath the trailer.
8. Adjust the landing legs to raise the trailer so it will clear the fifth wheel.
9. Pull the tractor forward to clear the trailer.



**Figure 52** - Dump valve used with electronic scale



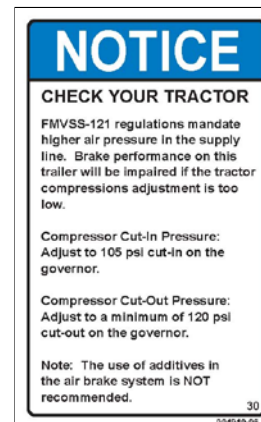
**Figure 53** - Dump valve used with air gauge

## A NOTE ON AIR PRESSURE

U.S. Federal Motor Vehicle Safety Standards part 121 now requires that the air compressor on all tractors pulling trailers must have higher air pressure levels in the supply line. This is required because the performance of modern brake systems requires higher pressures.

Because of this, you must check the pressure settings on the compressor governor on your tractor. If set properly, the compressor should cut-in at 105 psi and should cut-out at a minimum of 120 psi (Figure 54).

Do not attempt to tow your Eagle Bridge™ trailer if your tractor does not meet these requirements.



**Figure 54-** Air Pressure Decal

## LOADING THE TRAILER

When loading the trailer, the load must be distributed uniformly from the rear to the front. Read the following decals (Figures 55, 56 and 57) regarding loading safety. If you haul products that are granular and tend to flow, it is strongly recommended that you load the trailer from the rear forward. This will reduce the tendency for the material to force the chain flaps up, allowing the product to become lodged underneath the flaps. Your chain will last longer and require less frequent maintenance if you load in this manner.

If your trailer has a slide-up small door, make sure the safety latches at the bottom of the large door are securely latched before loading or towing the trailer.

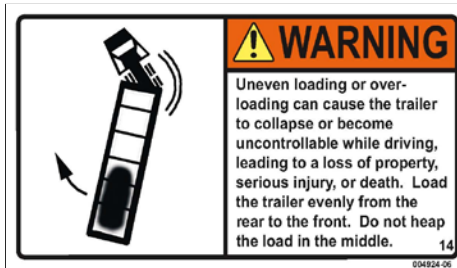


Figure 55 - Uneven Loading Decal



Figure 56 - Door Load Warning Decal



Figure 57 - Fall Decal

If your trailer is equipped with a LSAS (Load Sensing Axle System) lift control it is required that the trailer parking brakes are set when loading. The decal shown in Figure 58 will be affixed to the trailer near the glad hand.



**Figure 58 - LSAS Caution Label**

## **ELECTRONIC SCALES**

If your trailer is equipped with an electronic on-board scale, the power is provided by the center pin of the 7-way plug.



**Figure 59 - Air-Weigh® LoadMaxx™**



**Figure 60 - Air-Weigh® QuickLoad™**

## **LIFT AXLE CONTROLS**

Trinity Trailer uses multiple lift axle controls to meet the needs of our customers. Please review the following to locate the instructions that apply to your trailer.

### **EQUALIZING LIFT CONTROLS**

The following are equalizing lift controls that may be used on your trailer. When the axle is in the down position the air pressure in the ride bags will be equal to the other air ride axles on the trailer.

## AKAD2010 LIFT AXLE CONTROL



**Figure 61 - AKAD2010 Lift Control**

With this lift control (Figure 61) the operator can select the position of the axle. The axle is controlled manually by shifting the position of the plunger. When the plunger is in the down position the axle is in the raised position. The control is equipped with a solenoid that the customer may connect to a switch to control the axle electrically. When wiring the solenoid connect one wire to switched +12VDC and the other wire to ground.

## LSAS (LOAD SENSING AXLE SYSTEM)



**Figure 62 - LSAS Lift Control**

This lift control (Figure 62) is designed to automatically lower one or more lift axles on the trailer when there is a load sensed in the trailer. The axle(s) can be manually lowered at any time or raised when there is no load sensed (Figure 63).

The axle(s) will automatically lower if attempts are made to raise them when a load is sensed. The LSAS is all pneumatic and does not rely on electrical power to operate. There is a warning label affixed to the trailer near each axle that is load sensed to warn operators to stand clear of axle (Figure 64).

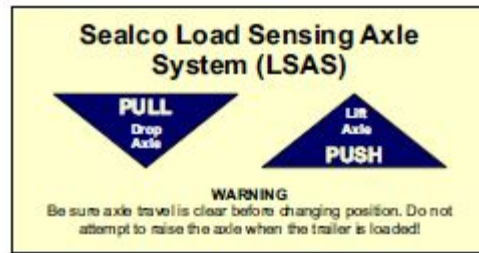


Figure 63 - LSAS Manual Operation Instructions Decal



Figure 64 - LSAS Warning Label

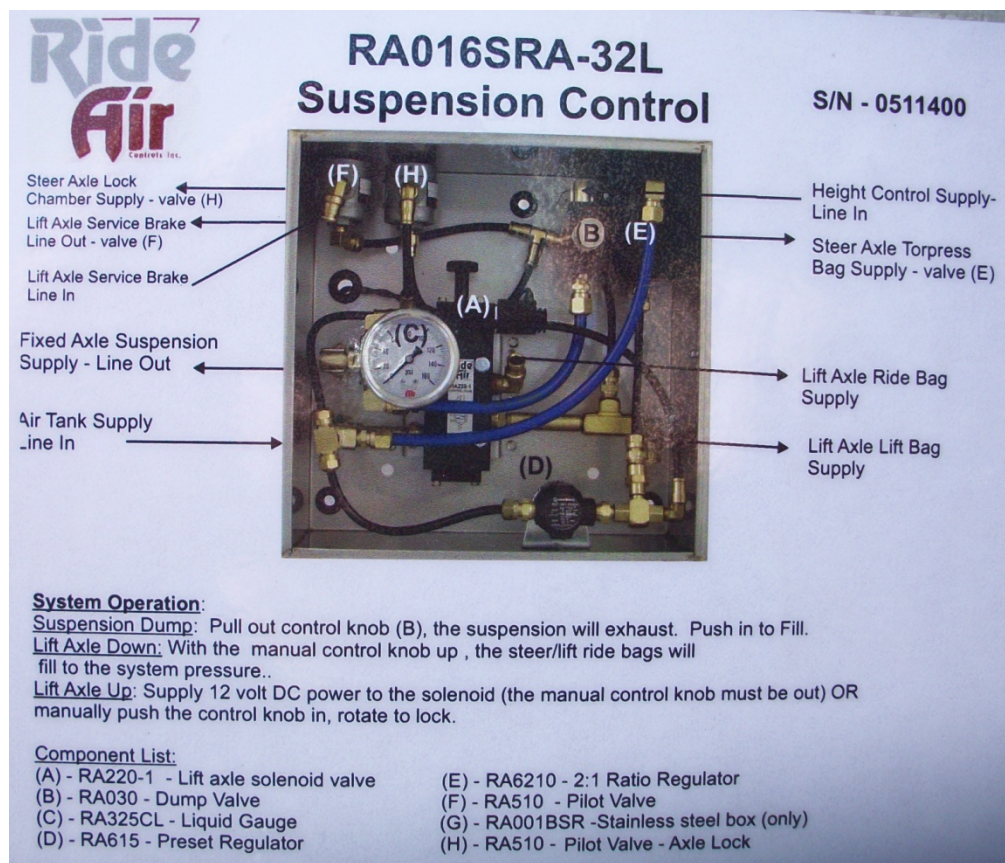
## RA016SRA-32L SUSPENSION CONTROL



Figure 65 - RA016SRA-32L Suspension Control

This control (Figure 65) is used with INGERSOLL ISS Series Self-Steering lift axles. It incorporates the suspension pressure gauge and dump valve into the same box as the lift control (Figure 66). It is used with a WHEEL MONITOR® INC., Reverse-A-Matic™ RM50 (Figure 67) system to automatically lift the axle when the trailer is moving backwards, and will drop the axle after 100' of forward movement. The axle can be manually lifted at any time using "valve A"(Figure 66).

The WHEEL MONITOR® INC., Reverse-A-Matic™ RM50 is supplied power from the center pin of the 7 way plug. The Operation and Installation Manual can be found on the CD included with this manual.



**Figure 66 - Suspension Control Components and Locations**



Figure 67 - Reverse-A-Matic™



Figure 68 - Reverse-A-Matic™ Caution Decal

## REGULATING LIFT CONTROLS

The following are regulating lift controls that may be used on your trailer. They allow the operator to adjust the air pressure going to the ride bags, allowing the operator to adjust the amount of weight carried on the lift axle.



## HAC - USO/LSO



**Figure 69 - HAC - USO/LSO Lift Control**

This lift control (Figure 69) is used with Compositite™ auxiliary axles. The axle can be raised/lowered manually or there is an electric solenoid that the operator can connect.

### For Initial Air Spring Adjustment

1. With a loaded trailer, position lowered axle on a certified scale.
2. Pull regulator knob out to unlock.
3. If pressure is high, adjust regulator to desired load then adjust 15 psi below current gauge value, next slowly increase pressure until the scale indicates desired axle load.
4. Push regulator knob in to lock setting
5. Read and record gauge value for desired axle load.

### **IMPORTANT**

Axle load can now be reset as needed. Periodically repeat above procedure to verify gauge accuracy.

## AKAD2011 LIFT CONTROL



**Figure 70 - AKAD2011**

With this lift control (Figure 70) the operator can select the position of the axle. The axle is controlled manually by shifting the position of the plunger. When the plunger is in the down position, the axle is in the raised position. The control is equipped with a solenoid that the customer may connect to a switch to control the axle electrically. When wiring the solenoid connect one wire to switched +12VDC and the other wire to ground.

### For Initial Air Spring Adjustment

1. With a loaded trailer, position lowered axle on a certified scale.
2. Pull regulator knob out to unlock.
3. If pressure is high, adjust regulator to desired load then adjust 15 psi below current gauge value, next slowly increase pressure until the scale indicates desired axle load.
4. Push regulator knob in to lock setting
5. Read and record gauge value for desired axle load.

### **IMPORTANT**

Axle load can now be reset as needed. Periodically repeat above procedure to verify gauge accuracy.

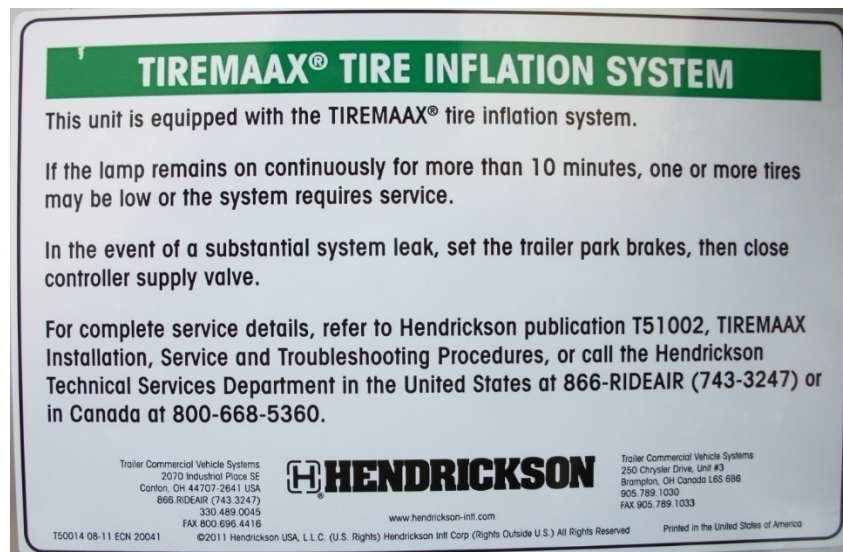
## TIRE INFLATION SYSTEMS

### TIREMAAX® PRO

The TIREMAAX® PRO tire inflation system maintains a constant regulated target tire pressure by using trailer air tank supply to inflate tires to the target pressure or deflating tire air pressure as needed. The system is equipped with an indicator lamp that illuminates when tires are being inflated (Figure 71). The controller module is usually mounted to a cross member near the middle of the suspension. Service and troubleshooting procedures can be found in Hendrickson publication T51002 supplied with the trailer or found on the CD included with this manual.



**Figure 71 - Tire Inflation System Indicator Lamp**

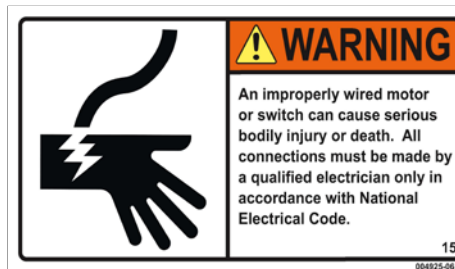


**Figure 72 - TIREMAAX® Decal Affixed to Trailer**

## DRIVE AND HYDRAULIC SYSTEMS

### SUPPLYING POWER TO THE ELECTRIC MOTOR

Because there are various types of receptacles, trailers equipped with electric motors do not have a plug attached to the wire pigtail at the factory. Consult a qualified electrician to determine the type and rating of plug needed and to have it installed (Figures 73 and 74). If a longer cord is necessary, use a plug to make the connection between the pigtail and the cord-**DO NOT** splice the conductors!

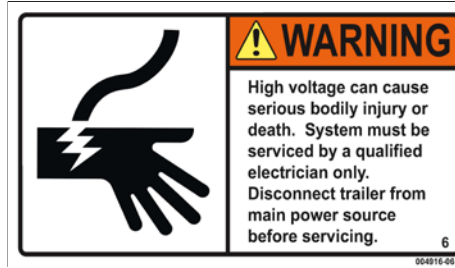


**Figure 73 - Motor Wiring Decal**

You will also need to determine the appropriate size of extension cord needed for your application. The lengths given in Table 2 are the maximum recommended length for single-phase 220 VAC with a 2% maximum voltage drop. Consult a qualified electrician if your trailer uses a motor other than a single-phase 7- 1/2 HP motor for proper cord sizes and lengths.

<b>7-1/2HP Single Phase</b>	
<b>Conductor Size (AWG)</b>	<b>Max Cable Length (Ft)</b>
14	NOT RECOMMENDED
12	NOT RECOMMENDED
10	NOT RECOMMENDED
8	240
6	350

**Table 2-Maximum Length for Electrical Motor Cord Size, 1Ø 220 VAC**



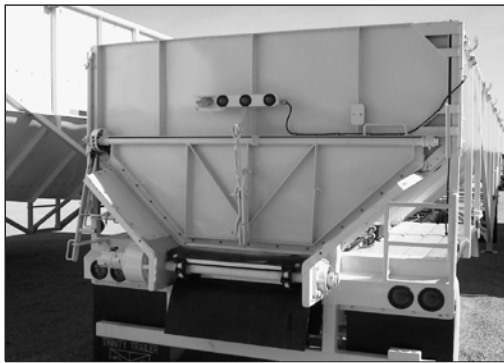
**Figure 74 - Electrical Servicing Decal**

## **OPERATING THE REAR DOOR(S) AND UNLOADING SYSTEM**

Trinity Trailer manufactures multiple rear doors to meet the needs of our customers. Please review the following pages to locate the instructions which apply to your door.

### **DOOR AND CONVEYOR SYSTEM COMPONENT IDENTIFICATION**

#### **Lower Door Identification**



**Figure 75 - Manual Flip-Up  
Lower Door**



**Figure 76 - Hydraulic Flip-Up  
Lower Door**

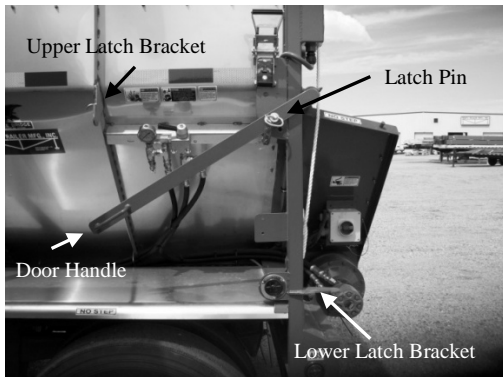


**Figure 77 - Manual "Spud" Lower Door**

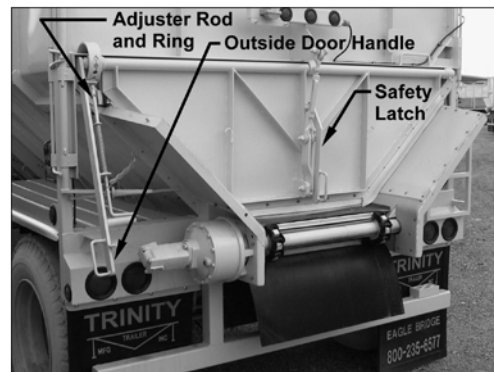


**Figure 78 - Hydraulic Slide-Up Lower Door**

### Lower Door Component Identification



**Figure 79 - Manual "Spud" Door Components**



**Figure 80 - Manual Flip-Up Door Components**

## Upper Door Identification



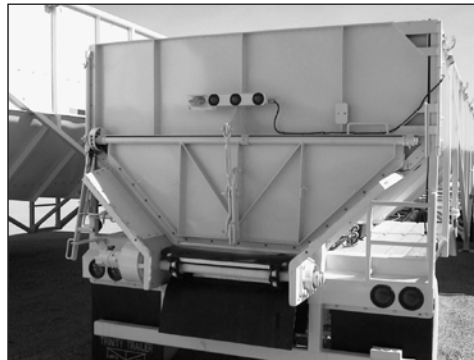
**Figure 81** - "Spud" Door



**Figure 82** - Full Swing "Spud"  
With Manual Flip-Up Door



**Figure 83** - Full Swing "Spud"  
With Hydraulic Flip-Up Door



**Figure 84** - Full Swing  
With Manual Flip-Up Door



**Figure 85** - Full Swing  
With Hydraulic Flip-Up Door



**Figure 86** - Full Swing  
With Hydraulic Slide-Up Door



**Figure 87** - Pneumatic Lift Top-Hinge with No Lower Door



**Figure 88** - Hydraulic Lift Top-Hinge with No Lower Door



**Figure 89** - Hydraulic Lift Top-Hinge with Hydraulic Flip-Up Door



**Figure 90** - Hydraulic Lift Top-Hinge with Hydraulic Slide-Up Door



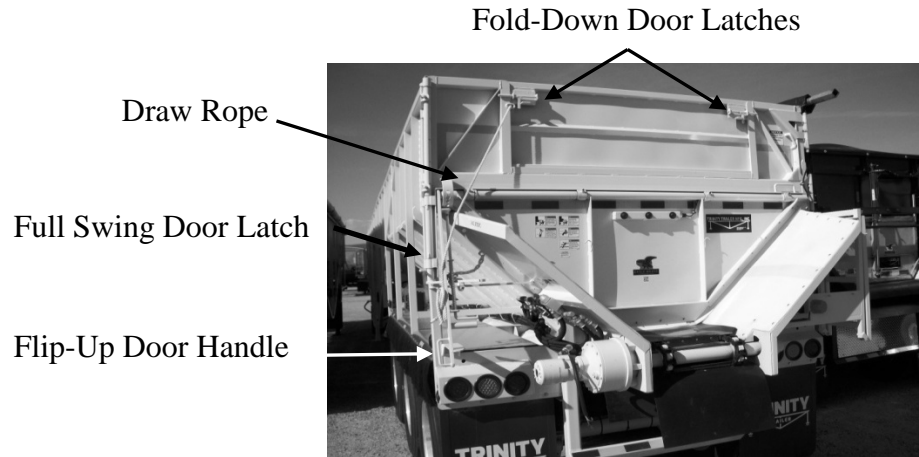


**Figure 91 - Hydraulic Lift Top-Hinge "Spud"  
With Hydraulic Flip-Up Door**

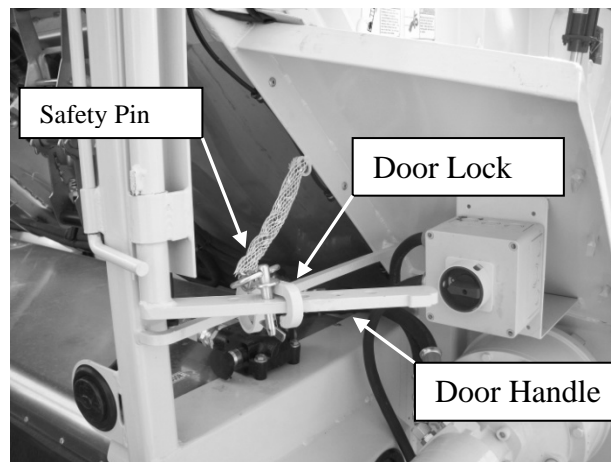
### Upper Door Component Identification



**Figure 92 - "Spud" Door Components**



**Figure 93 - Full-Swing "Spud" Door Components**



**Figure 94 - Full-Swing Door Latch Components**



Chain to hold door open

**Figure 95 - Full-Swing Door, Curbside**



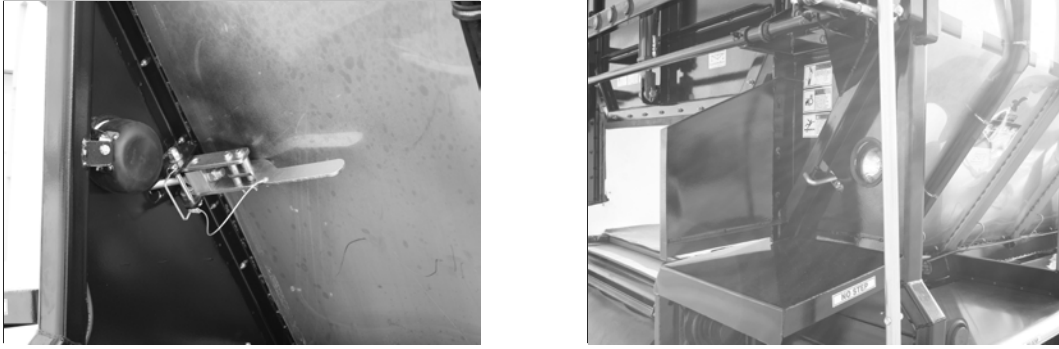
**Figure 96 - Top Hinge Pneumatic Latches**



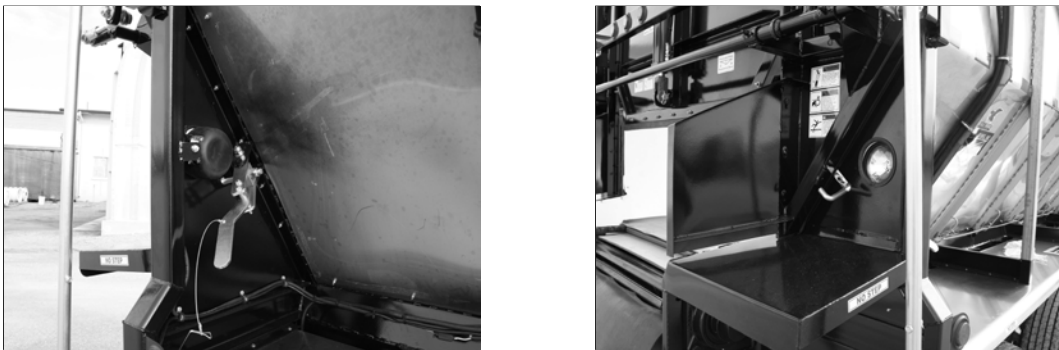
**Figure 97 - Top Hinge Pneumatic Latch Engaged**



**Figure 98 - Top Hinge Pneumatic Latch Disengaged**



**Figure 99 - Slide-Up Door Clamp Latch Secured**

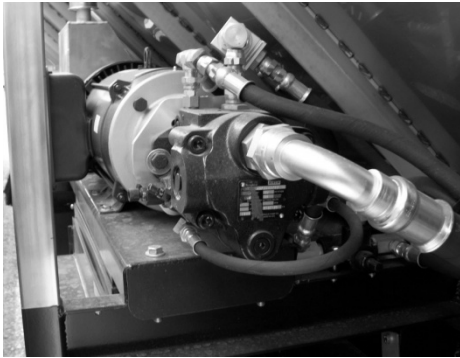


**Figure 100- Slide-Up Door Clamp Latch Disengaged**

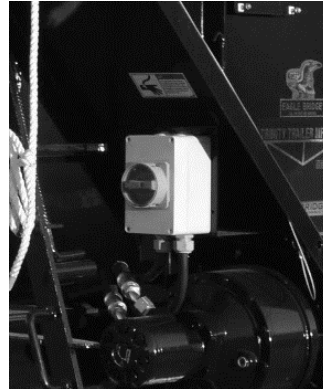
**Unload Drive System Identification**



**Figure 101 - 20 HP Gas Engine  
(Shown in Optional Enclosure)**

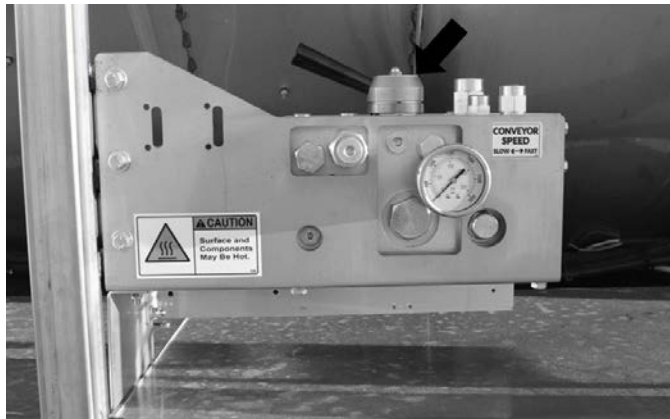


**Figure 102** - Electric Motor



**Figure 103** - Electric Motor Power Switch

### Door and Conveyor Controls



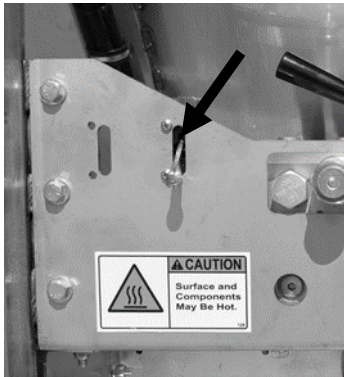
**Figure 104** - Manifold - Arrow Indicates the Conveyor Flow Control



**Figure 105-** Single Door Valve



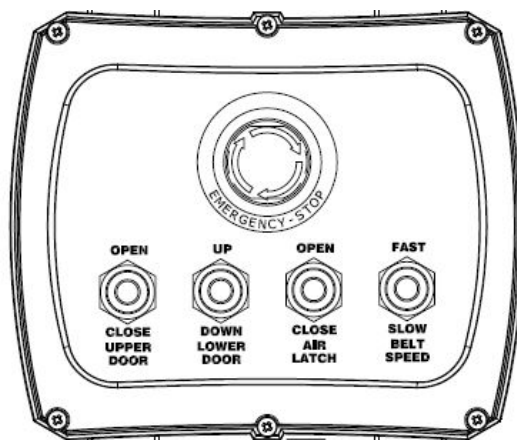
**Figure 106 -** Dual Door Valves



**Figure 107 -** Flipper Valve for Pneumatic Door Latch

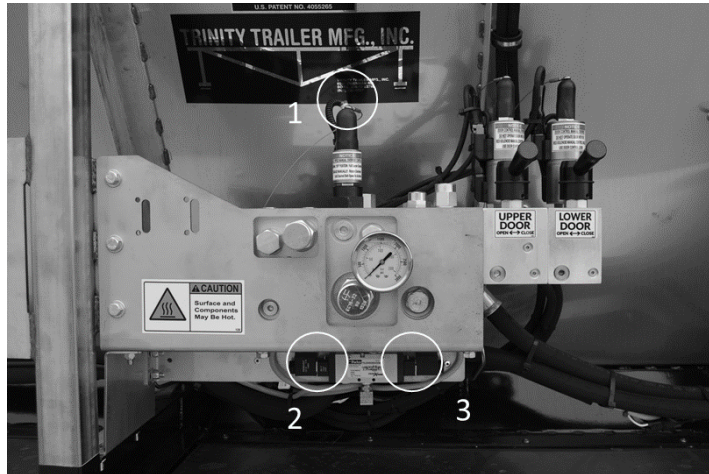


**Figure 108 -** DC Hydraulic Control Unit



**Figure 109 -** Wired Remote Control Panel

To operate the wired remote control, use the switches above as labeled. For the doors, lifting the switches up will open the door while down will shut the door. For the air latch, lifting up will unlock the latch while down will lock the latch. For the belt, clicking the switch up will increase the belt speed incrementally, 20 clicks will operate the belt at full speed. If the belt speed switch is lifted for 3 second the belt will automatically run at full speed. Pushing down on the switch slow the belt down, holding the switch down for 3 seconds will stop the belt. Pressing the emergency stop button will stop the whole system immediately.



**Figure 110**-Manifold with Solenoid Controls

## GENERAL DOOR SAFETY

Figures 111 through 115 are decals that were installed on your trailer when it was built regarding the safe operation of the rear door(s). Completely read through this information and adhere to it when operating the door(s).



**Figure 111** - Door Security Decal



**Figure 112** - Door Opening Sequence



Figure 113 - Getting Behind Trailer Decal



Figure 114 - Overhead Door decal



Figure 115 - Slide-Up Door Decal

## GENERAL CONVEYOR SAFETY

The conveyor system on your trailer can be very dangerous if it is not operated properly. Figures 116 through 118 show decals that were placed on your trailer when it was built. Read and understand each of them before operating the conveyor system.



Figure 116 - Conveyor with Doors Closed Decal



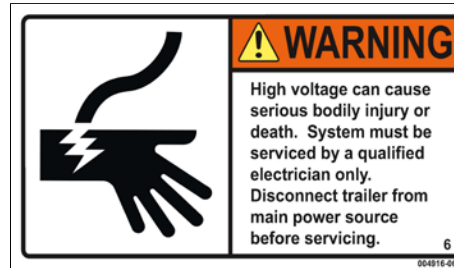


Figure 117 - Voltage Warning Decal



Figure 118 - Hydraulic Valve Decal

## UNLOAD OPERATING PROCEDURES

### ENGAGE HYDRAULIC SYSTEM

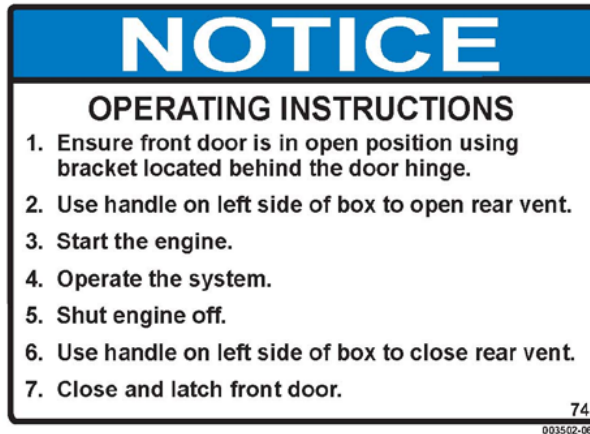
#### 1. ELECTRIC MOTOR-DRIVEN HYDRAULIC SYSTEM (FIGURE 108 pg.60)

- A. Verify that the power switch for the electric motor (Figure 103 pg.63) is in the OFF position.
- B. Verify the conveyor flow control valve is in the OFF position. Manual flow control (Figure 103 pg.63) should be rotated so handle points to the front of the trailer. Solenoid flow control (Figure 110 item 1 pg.65) the red knob should be turned fully counter clockwise.
- C. Plug the electric motor into an approved which is appropriately sized and has the necessary safety mechanisms to properly operate the motor. It is the operator's responsibility to ensure that the installation is safe.
- D. Switch the power switch for the electric motor to the ON position.

#### 2. GAS ENGINE-DRIVEN HYDRAULIC SYSTEM (FIGURE 102 pg.63)

- A. Verify the conveyor flow control valve is in the OFF position. Manual flow control (Figure 103 pg.63) should be rotated so handle points to the front of the trailer. Solenoid flow control (Figure 110 item 1 pg.65) the red knob should be turned fully counter clockwise.

- B. Start the engine in accordance with the engine owner's manual. If you have the optional motor box, use the instructions shown below in Figure 119.
- C. Set the engine throttle full open.



**Figure 119 - Operating Instructions for a Honda 20HP Gasoline Engine With Optional Motor Box**

### **TRACTOR-DRIVEN PTO HYDRAULIC SYSTEM**

- D. Verify the conveyor flow control valve is in the OFF position. Manual flow control (Figure 103 pg.63) should be rotated so handle points to the front of the trailer or with solenoid flow control (Figure 110 item 1 pg.65) the red knob should be turned fully counter clockwise.
- E. Check the connections between the tractor and the trailer to ensure the pressure and return lines are connected properly and securely.
- F. Engage the PTO on the tractor.

**NOTE**

The following procedures are for using trailer mounted controls.

Power for the optional wired remote panel is obtained from the center pin of the 7-way socket.

### **OPEN THE REAR DOOR**



Do not get behind a loaded trailer with the door(s) open. The trailer's contents could spill on you causing serious injury or death.



Moving conveyor parts can crush and cut and cause serious bodily injury or death. Keep away from all moving parts while they are in motion.



Door can crush and cut. Keep away from door while operating to prevent bodily injury.

## 1. LOWER DOOR PROCEDURES

### A. MANUAL FLIP-UP DOOR (Figure 75 pg.55)

- i. Release the safety latch located on the flip-up door (Figure 80 pg.56) by pulling the handle out away from the trailer door (if equipped).
- ii. Pull the outside door handle out of the retaining slot.
- iii. Squeeze the adjuster rod on the handle until it comes out of the adjuster ring.
- iv. Raise the handle until the desired opening is reached.
- v. Release the adjuster rod into the nearest hole in the adjuster ring.

### B. MANUAL FLIP-UP SPUD DOOR (Figure 77 pg.56)

- i. Remove the latch pin (Figure 79 pg.56) from the door handle.
- ii. Pull the handle out away from the trailer to release the handle from the upper latch bracket.
- iii. Pull down on the handle until the door reaches the desired opening and replace the latch pin back in the door handle or secure handle in lower latch bracket.

### C. HYDRAULIC FLIP-UP OR SLIDER DOOR (Figure 76 pg.55 or 78 pg.56)

- i. Control from manifold location (Figure 104 pg.63).
  1. Rotate the handle on the door valve labeled "Lower Door" (Figure 105 or 106 pg.64) towards the front of the trailer to open the door to the desired height.
- ii. Control from optional wired remote panel (Figure 109 pg.64).
  1. Hold the toggle switch labeled "Lower Door" to the UP position to open the door to the desired height.
- iii. Control from optional DC unit.
  1. Make sure the electrical supply from the tractor to the trailer is properly connected.
  2. Push the up arrow button on the DC control unit (Figure 108 pg.64) to open the door to the desired height.

## 2. UPPER DOOR PROCEDURES

### A. Full-Swing Door (Figures 82-86 pg.57)

- i. Open the lower door enough to clear the tailfins using the appropriate procedure above.
- ii. If lower door is a slide-up door release the clamps located on each side of the lower door (Figure 99-100 pg.62).
- iii. Remove the safety pin from the handle (Figure 94 pg.60).
- iv. Slide the door lock to the roadside of the trailer and disengage from the handle.
- v. Pull the handle to disengage the side latches.
- vi. Pull the full-swing door toward the curbside of the trailer and secure the door open with the chain and pin provided (Figure 95 pg.60).

**B. Top-Hinge Door with Pneumatic Latch and Pneumatic Lift (Figure 87 pg.58)**

- i. Control from manifold location (Figure 104 pg.63).
  - 1. Move the toggle valve (Figure 107 pg.64) up or press button on solenoid valve (Figure 110 item 3 pg.65) to release the door latches (Figure 98 pg.61). This will also slowly activate the pneumatic cylinder which will hold the door open after the load has discharged. The door will be held partially open to allow all of the product to leave the trailer. *Note: The pneumatic cylinder is not intended to open the door; it merely helps support it.*
- ii. Control from optional wired remote panel (Figure 109 pg.64).
  - 1. Press the toggle switch labeled "Air Latch" to the open position to release the door latches (Figure 98 pg.61). This will also slowly activate the pneumatic cylinder which will hold the door open after the load has discharged. The door will be held partially open to allow all of the product to leave the trailer. *Note: The pneumatic cylinder is not intended to open the door; it merely helps support it.*

**C. Top-Hinge Door with Pneumatic Latch and Hydraulic Lift (Figure 88-91 pg.58-59)**

- i. If equipped open the lower door enough to relieve seal from conveyor using the appropriate procedure above.
- ii. If lower door is a slide-up door release the clamp latches on each side of the lower door (Figure 99-100 pg.62).
- iii. Control from manifold location (Figure 104 pg.63).
  - 1. Move the toggle valve up (Figure 106 pg.64) or press button on solenoid valve (Figure 110 item 3 pg.65) to release the pneumatic latches (Figure 98 pg.61).
  - 2. Rotate the handle on the door valve labeled "Upper Door" (Figure 105 or 106 pg.64) towards the front of the trailer to raise the door completely.
- iv. Control from optional wired remote panel (Figure 109 pg.64).
  - 1. Press the toggle switch labeled "Air Latch" to the OPEN position to release the door latches (Figure 98 pg.61).
  - 2. Hold the toggle switch labeled "Upper Door" to the OPEN position to open the door to the desired height.

## **OPERATE THE CONVEYOR**

- A.** Open rear door using appropriate procedure above.
- B.** Control from Manifold location
  - i.** Rotate the flow control valve (Figure 104 pg.63) counter clockwise 2-3 clicks or with solenoid flow control (Figure 110 item 1 pg.65) rotate the red knob clockwise until pressure starts to increase on gauge. If conveyor does not start moving, check the pressure reading on the gauge. If it is still increasing, wait until it reaches full operating pressure (2500 PSI). If conveyor still does not move, **DO NOT** increase the flow control setting. Call Trinity Trailer Mfg., Inc. at 1-800-235-6577 for assistance.
  - ii.** Adjust the flow control to obtain the desired conveyor speed.
  - iii.** To stop the conveyor rotate the flow control valve clockwise until the handle is pointed towards the front of the trailer or with the solenoid flow control rotate the red knob counter clockwise to full stop.
- C.** Control from optional wired remote panel (Figure 109 pg.64)
  - i.** Press and release the toggle switch labeled "Belt Speed" to the FAST position 2-3 times. If conveyor does not start moving, check the pressure reading on the gauge. If it is still increasing, wait until it reaches full operating pressure (2500 PSI). If conveyor still does not move, **DO NOT** increase the flow control setting. Call Trinity Trailer Mfg., Inc. at 1-800-235-6577 for assistance.
  - ii.** Adjust the conveyor to the desired speed. Each press and release of the toggle switch labeled "Belt Speed" to the FAST or SLOW position will increase or decrease the conveyor speed by 10%.
  - iii.** To stop the conveyor rotate the EMERGENCY STOP button clockwise.

## **CLOSE THE REAR DOOR**

### **1. UPPER DOOR PROCEDURES**

- A. Full-Swing Door (Figures 82-86 pg.57)**
  - i.** Remove and store the pin and chain that is holding the door open (Figure 95 pg.60).
  - ii.** Pull the full-swing door toward the roadside of the trailer.
  - iii.** With the handle rotated fully to the left and the side latches pulled away from the trailer, pull the door closed.
  - iv.** Push the side latches toward the trailer and rotate the handle to the right to engage the side latches.
  - v.** Engage the door lock over the handle and slide to the curbside of the trailer to hold the handle tight (Figure 94 pg.60).
  - vi.** Insert the safety pin in the handle to hold the door lock in place.
  - vii.** If the lower door is a slide-up door engage the clamps on each side of the lower door (Figure 99-100 pg.62).

viii. Close the lower door using the appropriate procedure below.

**B. Top-Hinge Door with Pneumatic Latch and Pneumatic Lift (Figure 87 pg.58)**

- i. Control from manifold location (Figure 104 pg.63).
  1. Move the toggle valve (Figure 107 pg.64) down or press button on solenoid valve (Figure 110 item 2 pg.65) to release air from the pneumatic cylinder, allowing the door to close and latch.
  2. Make sure the latches are fully engaged on the pins (Figure 97 pg.61).
- ii. Control from optional wired remote panel (Figure 109 pg.64).
  1. Press the toggle switch labeled "Air Latch" to the CLOSE position to release air from the pneumatic cylinder, allowing the door to close and latch.
  2. Make sure the latches are fully engaged on the pins (Figure 97 pg.61).

**C. Top-Hinge Door with Pneumatic Latch and Hydraulic Lift (Figure 88-91 pg.58-59)**

- i. Control from manifold location (Figure 104 pg.63).
  1. Rotate the handle on the door valve labeled "Upper Door" (Figure 105 or 106 pg.64) towards the rear of the trailer to lower the door completely.
  2. Move the toggle valve (Figure 107 pg.64) down or press button on solenoid valve (Figure 110 item 2 pg.65) to lock the pneumatic latches. Make sure the latches are fully engaged on the pins (Figure 97 pg.61).
  3. If equipped with a lower slide-up door engage the clamp latches on each side of the lower door (Figure 99-100 pg.62).
  4. If equipped close the lower door using the appropriate procedure below.

**2. LOWER DOOR PROCEDURES**

**A. MANUAL FLIP-UP DOOR (Figure 75 pg.55)**

- i. Squeeze the adjuster rod on the handle until it comes out of the adjuster ring.
- ii. Lower the handle until it engages in the retaining slot.
- iii. Release the adjuster rod.
- iv. Engage the safety latch located on the flip-up door (Figure 80 pg.56) by pushing the handle in towards the trailer door (if equipped).

**B. MANUAL FLIP-UP SPUD DOOR (Figure 77 pg.56)**

- i. Pull the handle out away from the trailer or remove the latch pin from the handle.
- ii. Swing the handle up until it latches on the upper latch bracket.
- iii. Replace the latch pin in door handle (Figure 79 pr.56).

**C. HYDRAULIC FLIP-UP OR SLIDER DOOR (Figure 76 pg.55 or 78 pg.56)**

- i. Control from manifold location (Figure 104 pg.63).

1. Rotate the handle on the door valve labeled "Lower Door" (Figure 105 or 106 pg.64) towards the rear of the trailer to close the door to the desired height.
- ii. Control from optional wired remote panel (Figure 109 pg.64).
  1. Hold the toggle switch labeled "Lower Door" to the DOWN position to close the door to the desired height.
- iii. Control from optional DC unit.
  1. Make sure the electrical supply from the tractor to the trailer is properly connected.
  2. Push the down arrow button on the DC control unit (Figure 108 pg.64) to close the door to the desired height.

## **OPERATING LOADING ACCESS DOORS**

### **FOLD-DOWN SPUD DOOR**

#### **Opening the Fold-Down Spud Door (Figure 92 pg.59 or Figure 93 pg.60)**

1. Release the two latches at the sides of the fold-down door by raising the lever and sliding the latch toward the center of the door.
2. Untie the draw rope.
3. Gently lower the door using the draw rope to keep it from falling rapidly.

#### **Closing the Fold-Down Spud Door (Figure 92 pg.59 or Figure 93 pg.60)**

1. Pull on the draw rope to raise the fold-down door.
2. Tie off the draw rope to hold the fold-down door in position.
3. Secure the two latches at the sides of the fold-down door by raising the lever and sliding the latch towards the outside of the door.

### **FOLD-DOWN EXTENSION (SIDEBOARD) DOOR**

Your trailer may be equipped with a fold-down door(s) in the sideboard of the trailer (Figure 120). Use the following instructions for operating this door. **Use caution when operating this door as it can fall rapidly (Figure 122).**



**Figure 120 - Fold-Down Sideboard Door**



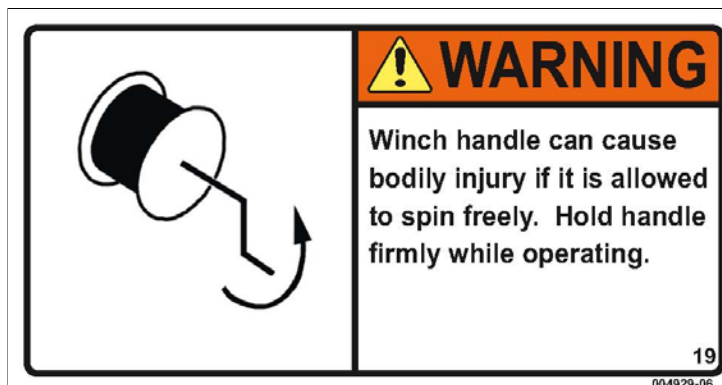
**Figure 121 - Fold-Down Sideboard Door Operator Winch**



**Figure 122 - Fold-Down Door Decal**

### Opening the Door

1. Disengage the ratcheting lock on the winch (Figure 121) and unwind until the cable is slack, adhering to the warnings shown in Figures 123 and 124. Re-engage the lock.
2. Pull on the draw rope to start the door opening.
3. Disengage the winch lock again and slowly unwind the cable, allowing the door to open completely.



**Figure 123 - Moving Winch Parts Decal**



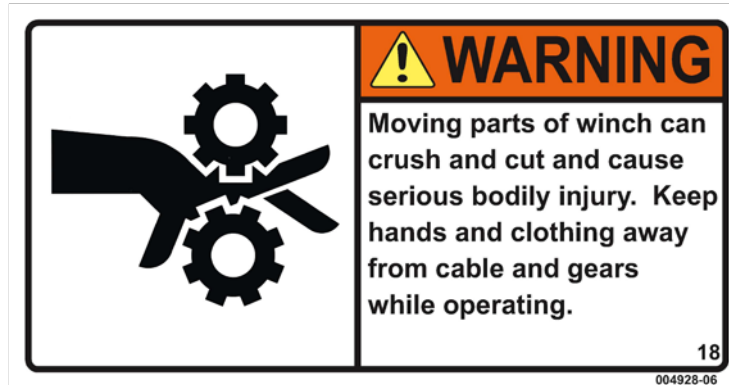


Figure 124 - Winch Decal

### Closing the Door

1. Engage the ratcheting lock (Figure 121).
2. Slowly wind the crank until there is a little tension on the cable.
3. Use the draw rope to pull the door out away from the trailer.
4. Continue winding the crank until the door is fully closed.

## OPERATING THE PNEUMATICALLY-ACTUATED FRONT WET SEAL

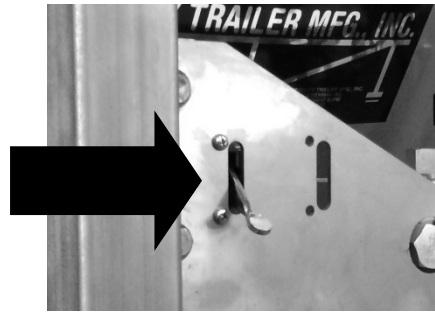
Some trailers are equipped with a front wet seal (Figure 126) operated with air pressure from a pneumatic reservoir. If the reservoir does not have sufficient pressure in it to actuate the seal, the trailer should be connected to the air supply from the tractor.



Figure 125 - Warning Label for Pneumatically-Actuated Front Wet Seal



**Figure 126** -Pneumatically-Actuated Front Wet Seal



**Figure 127** - Control Valve for Pneumatically-Actuated Front Wet Seal

The control valve used to operate the front wet seal is located at the rear of the trailer near the controls for the conveyor and/or door (Figure 127). Raise the toggle valve up to open the seal and down to close it. The rubber seal must have a chain crossbar from the conveyor system located under it in order to obtain a good seal

**IMPORTANT**

The applicable procedure for closing the rear door(s) must be followed before the front seal is closed.

The front seal must be opened before the trailer is unloaded.

**USING THE REMOVABLE TAILFINS**

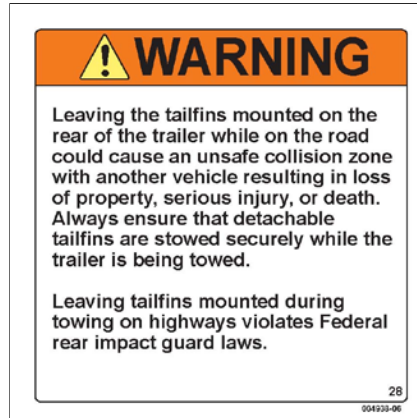


Do not get behind a loaded trailer with the door(s) open. The trailer's contents could spill on you causing serious injury or death.



Moving conveyor parts can crush and cut and cause serious bodily injury or death. Keep away from all moving parts while they are in motion.

Some trailers are equipped with removable tailfins. These fins are used while unloading the trailer to help direct the load onto a hopper or an elevator. Use of these removable tailfins on the road is a violation of the federal rear impact guard law (Figure 128). Trinity Trailer is not liable for any action against the owner or operator resulting from installation of these tailfins on the trailer while the trailer is on the road. It is the responsibility of the owner or operator to verify that the tailfins are removed from the rear of the trailer before using the trailer on the road. You will find the following decal located on each tailfin.



**Figure 128 - Tailfin Decal**



**Figure 129 - Tailfin Stowed**



**Figure 130 - Tailfin Mounted**

Figures 129 and 130 show how the tailfins are stowed when they are not in use and how they mount to the rear of the trailer, respectively.

## TARP SYSTEMS

Your trailer may be equipped with one of three types of tarps. The standard tarp is a manual rollover tarp that is attached to the curbside of the trailer. When the tarp is rolled over the top of the trailer, secure it in place with the attached straps to the ratchets which are mounted on the roadside of the trailer. If there is a flap on the front or back of the tarp, secure with bungees to make sure the tarp seals. The handle for the tarp is removable and is stowed behind the ladder on the roadside of the trailer (Figure 131).

**Do not** leave the handle attached to the tarp while driving unless the trailer is equipped with crank retainers.



**Figure 131 - Rollover Tarp Handle Stored**

The second type of tarp is a Shur-Lok® style roll tarp system by Shur-Co®. This tarp is similar to the standard rollover tarp; however, it does not use straps to secure it when unrolled. On the roadside of the trailer is a 4-inch latch plate, or overhang, attached to the top of the trailer. When you unroll the tarp, continue rolling it past the latch plate until it is completely unrolled. Continue to turn the crank handle in the same direction so the tarp starts rolling up underneath the latch plate. Once the tarp has tension on it, lock the handle in the crank retainer on the roadside of the trailer (Figure 133). The Shur-Co® illustration in Figure 134 shows these steps. Figure 132 shows this tarp rolled up.

The third type of tarp is an electrically operated Shur-Lok® style. This tarp has an electric motor and control arm system. A rocker switch on the front of the trailer (Figure 135) operates the system. To open the tarp, push and hold the rocker switch until the tarp rolls over the trailer and against the tarp stops. To close the tarp, push and hold the rocker switch until the tarp has rolled all the way down and rolled back up against latch plate.

Electrically operated Shur-Lok® style tarps may be equipped with a wireless SMART2™ remote control.

1. The remote will power up when the lid is opened. If the lid is open and the remote is off, power the remote by pressing either of the operational buttons.
2. When the lid is opened, the remote will default to the Main Menu screen.
3. Use the up/down arrow keys to highlight the tarp.
4. The tarp can be operated in Manual Mode by pressing and holding the Open or Close buttons.
5. While the tarp is operating the current position of the tarp will be displayed on the screen.
6. The remote will power down when the lid is closed or when the lid is left open for three minutes after the last button is pushed.

# CAUTION

On Agri-Flex trailers the tarp should be left open when not in transit to prevent accumulation of water or snow.



Figure 132 - Shur-Lok® Tarp Rolled Up



Figure 133 - Shur-Lok® Roadside Hardware

## ATTENTION!

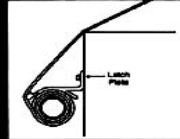
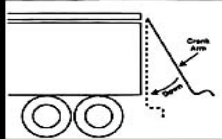
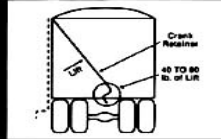
**THE TARP MUST BE KEPT TO A RECOMMENDED 40-60 LBS. OF TENSION OR EXCESSIVE TARP WEAR MAY OCCUR.**

**DO NOT WALK OR STAND ON THE END CAPS.**

**DO NOT OPERATE THIS VEHICLE AT HIGHWAY SPEEDS, WHILE THE TARP SYSTEM IS IN THE "OPEN" POSITION!**

---

### OPERATING INSTRUCTIONS

<p><b>1. Crank The Tarp Up Under The Latch Plate.</b></p> 	<p><b>2. Bring The Crank Arm Down To A Vertical Position.</b></p> 	<p><b>3. Lift The Crank Arm Up To The Crank Retainer.</b></p> 	<p><b>To Adjust The Tarp Tension</b></p> <ol style="list-style-type: none"> <li>1. Allow The Tarp To Roll Down Away From The Latch Plate.</li> <li>2. Remove The Crank Arm From The Splined Shaft.</li> <li>3. Rotate The Crank One Or Two Teeth And Reassemble.</li> </ol>
---	---	---	---

1100361      Shur-Co., Yankton, SD 1-800-4 SHUR-LOK (1-800-474-8756)      Patent No. 31746

Figure 134 - Shur-Lok® Tarp Decal



**Figure 135 - Electric Tarp Rocker Switch**

## **LADDER, WALKWAY AND CATWALK SAFETY**

You may have one or more ladders, walkways or catwalks on your trailer. If you do, review the following information thoroughly. Trinity Trailer has made every effort to reduce or eliminate the risk involved with using these devices.

Although there is always a risk in working on elevated areas, it is a fact that the vast majority of accidents involving ladders result from the failure to exercise care. Proper training, as well as routine inspections and maintenance can substantially reduce the number or ladder related injuries.

Never stand on the top two steps of any ladder or the top cap of a ladder. This could cause you to become off-balance resulting in a fall. Always maintain at least three points of contact with the ladder (2 feet and 1 hand or 2 hands and 1 foot should be in contact with the ladder at all times). Do not over-extend sideways. Use the belt buckle rule: Keep your belt buckle positioned between the side rails at all times, this will maintain your center of gravity in the proper position.

Below are cautions and warnings about ladders, walkways and catwalks that may be on your trailer. Review each of these thoroughly before using the trailer.



**Figure 136 - Secure Chain Decal**



**Figure 137 - Handhold Decal**



Figure 138 - Rung Warning Decal



Figure 139 - Top Two Rung Caution Decal



Figure 140 - Fall Protection Notice Decal



Figure 141 - Slipping Ladder Warning Decal

**NOTE (Figure 140)**  
**Fall protection device connections are located at every ladder, walkway and catwalk location on Eagle Bridge™ trailers.**



Figure 142 - Owner Responsibility Decal



Figure 143 - Above this Rung Decal



Figure 144 - Maintenance Ladder Safety Decal



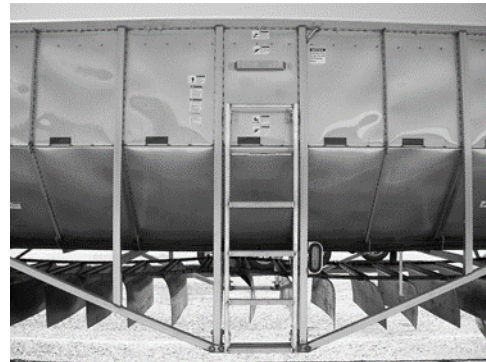
Figure 145 - Ladder General Caution Decal



## **LADDER USE PROCEDURE**



**Figure 146** - Front Ladder Showing Upper User Fall Protection Device



**Figure 147** - Roadside Ladder



**Figure 148** - Roadside Ladder Showing Offset

1. Inspect the ladder, components and hardware for visual signs of wear.
2. Inspect the ladder rungs for debris or ice which may cause an unsafe condition.
3. Inspect the area around the base of the ladder to ensure a firm footing area for mounting and dismounting the ladder.
4. Review the ANSI safety labels on and around the ladder.
5. Keep at least three points of contact with the ladder at all times.
6. Keep your buckle inside the ladder frame at all times.
7. If you are at or above four feet from the ground, you must use an OSHA approved fall protection harness.
8. For your safety, a fall protection harness attachment has been provided for all ladders, catwalks and walkways on Eagle Bridge™ trailers (Figure 149).
9. Pay special attention to the “Do not step or stand on or above this rung” warning decal. The rung at which the decal is placed and above is not designed as steps but rather as hand holds (Figure 143).



Attachment Point  
for User-Provided  
Fall Protection  
Device

**Figure 149** - User Fall Protection Device Attachment Point

10. Under no circumstances should there be more than one person on a ladder, catwalk or walkway on an Eagle Bridge™ trailer at any given time.
11. The ladders, catwalks and walkways found on Eagle Bridge™ trailers are designed for persons at least 5 feet tall and weighing 350 lbs. or less.
12. Never use a ladder, catwalk or walkway on an Eagle Bridge™ trailer without wearing closed toe shoes or boots.
13. Avoid loose clothing and/or jewelry around ladders, catwalks and walkways on Eagle Bridge™ trailers.
14. Do not use any ladders, catwalks or walkways on Eagle Bridge™ trailers during weather conditions that are conducive to lightning.
15. Always use both hands on the ladder, catwalk or walkway while mounting or dismounting.
16. Always inspect the ladder after use for any damage to the ladder, components or hardware.

## **REAR MAINTENANCE LADDER USE PROCEDURE**



**Figure 150 - Maintenance Ladder  
"Stowed" Position**



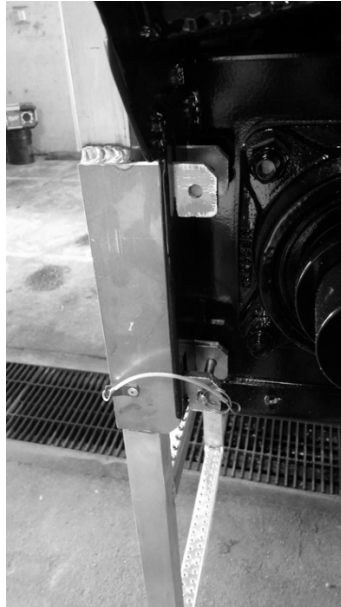
**Figure 151 - Locking Pin "Stowed"  
Position**



**Figure 152 – "In-use" Mount**



**Figure 153 – Ladder "In-use" position**



**Figure 154** – Locking pin “In-use” position

 **WARNING**

Getting inside the trailer with the door(s) closed or the hydraulic system energized can result in serious injury or death. Open door(s) and disable all hydraulic systems before entering the trailer.

1. Open the rear door (Follow procedures on pg.68-70).
2. Disengage the hydraulic system to prevent the conveyor from being operated.
3. Remove the locking pin (Figure 151) and remove the ladder from the “Stowed” position (Figure 150).
4. Place the ladder into the “In-use” position on the mount next to the conveyor (Figure 153).
5. Replace the locking pin (Figure 154).

**STOWING REAR MAINTENANCE LADDER**

1. Remove the locking pin (Figure 154) and remove the ladder from the “In-use” position (Figure 153).
2. Place the ladder into “Stowed” position on the mount on the side of the trailer (Figure 150).
3. Replace the locking pin (Figure 151).

## **TRAILER MODIFICATIONS**

The trailer has been engineered for maximum performance and longevity. Therefore, any modifications to the trailer will result in loss of warranty. Trinity Trailer Mfg., Inc. will not be liable for any modifications to the trailer without prior written consent. Should you desire to modify the trailer, please submit to Trinity Trailer Mfg., Inc. in writing your proposed changes along with drawings of those changes and any relating materials.



**Figure 155 - Top Rail Modification Decal**

## **REPORTING SAFETY DEFECTS**

Trinity Trailer Mfg., Inc.  
7533 S. Federal Way  
Boise, Idaho 83716  
(208) 336-3666  
(800) 235-6577  
Fax (208) 336-3741

### **Reporting safety defects**

If you believe that your vehicle has a defect which could cause a crash or could cause injury or death, you should immediately inform the National Highway Traffic Safety Administrations (NHTSA) in addition to notifying Trinity Trailer Mfg., Inc.

If NHTSA receives similar complaints, it may open an investigation, and if it finds that a safety defect exists in a group of vehicles, it may order a recall and remedy campaign. However, NHTSA cannot become involved in any individual problems between you, your dealer or Trinity Trailer Mfg., Inc.

To contact NHTSA, you may either call the Auto Safety Hotline toll-free at 1-800-424-9393 (336-0123 in Washington, DC area) or write to:

NHTSA  
U.S. Department of Transportation  
400 7<sup>th</sup> Street SW, (NSA-11)  
Washington, DC 20590

You can also obtain other information about motor vehicle safety from the Hotline.

**Thank You Again for Purchasing an Eagle Bridge™ Trailer.**

